

CONFIDENTIAL

SUGARCRETE

by CW Workshop 02

CONSTRUCTION WEEK 2021
UNIVERSITY OF EAST LONDON

Armor Gutierrez
Alan Chandler
Bamdad Ayati
Hidayati Yazmin Binti Abdul Halim
Mert Manas Erten
Mihriban Ustun
Oluchukwu Judith Obiejesi
Svetoslav Georgiev Slav
Rashmi Madagamage Gunathilaka
Orseer Isreal Gbashah
Mahmoud Sayed Abdellattif

22.10.2021



PREFACE

This report is a detailed piece of research dedicated to bagasse formed load bearing or insulation material. The idea was developed through the use of hemcrete in the construction industry. The purpose of this research is to teach interested readers how to use sugarcane residue could be used as a construction material, how it is made to use as a wall or as an insulation material with carbon negative impact to the environment. Following our productive research of two weeks we have created and tested different ratios of bagasse using other materials and experimented u value, strength testing and fire testing on our prototype models. This report will give a detailed explanation and step to step guide on how bagasse could be used as a construction material and the results of our testing and experiments. This experiment was undertaken by individuals with no prior experience in using bagasse as a construction material. We hope this report inspires you to explore the endless possibilities using bagasse and helping our future in the construction industry.

SPECIAL THANKS TO

It was an honour to finish this short and fun project as Group 2. We would like to first of all thank our Construction Week Workshop Instructor, Armor Gutierrez for always being supportive and engaging, and we would like to extend our thanks to Bamdad Ayati for the very informative and helpful information and lectures on U-Value calculations, Carbon Footprint calculations; his help and enormous contribution during the testing and experimenting of Bagasse. We would also like to thank Julia from Tate & Lyle Sugars and John from ASR Group for their informative presentations on Sustainable Raw Sugar Sourcing teaching us the detailed process of Sugar Cane farming and importing. And finally we would like to thank the AVA staff for letting us use the machinery & rooms.

TABLE OF CONTENTS

The Problem	0.0
Introduction	1.0
Materials	2.0
Manual Guide	3.0
Carbon Footprint Calculations	4.0
Fire Testing Report	5.0
U Value & Compressive Strength	6.0
Weathering Test	7.0
Photo Gallery	8.0
Potential Applications: Belize	9.1
Potential Applications: Brazil	9.2
Potential Applications: Malaysia	9.3
Potential Applications: Nigeria	9.4
Potential Applications: South Africa	9.5
References & Notes	10.0

FUNDAMENTAL BUILDING MATERIALS



BRICKS



CONCRETE

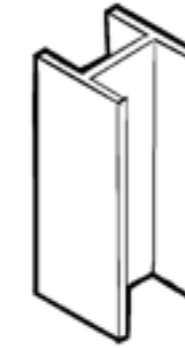

STEEL



TIMBER

0.1 THE PROBLEM WITH REGULAR BRICKS

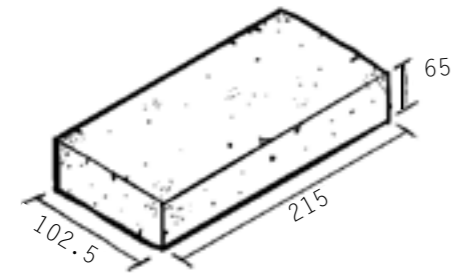

REGULAR UK BRICK

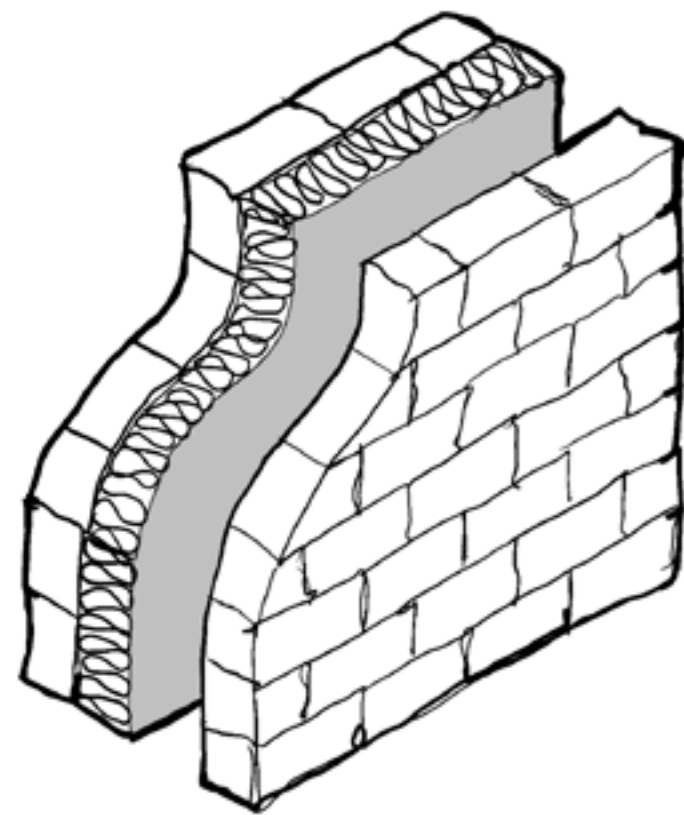

REGULAR UK BRICK WALL

ADVANTAGES

Fast and Easy Building: Bricks are very efficient in building durable walls, very quickly.

Material Cost: Regular clay bricks are a cheaper alternative to most of the contemporary building materials.

Compressive Strength: Bricks have a really high compressive strength, making them very efficient in low-rise buildings.

DISADVANTAGES

Imported Bricks: In 2019 UK imported \$33.4 M in Bricks, and became the 1st largest importer of bricks in the world.

Weight: Regular bricks are heavy to transport and carry during construction, and cover a small surface area per brick.

Layering: Contemporary brick walls are constructed using many layers that are required such as insulation, waterproofing and screening.

Energy Consumption: Brick production requires a lot of energy to heat up the brick, and this energy is mostly supplied from the primary grid electricity.

Construction Expenses: Regular brick wall construction is very expensive, rates reaching £40/hr.

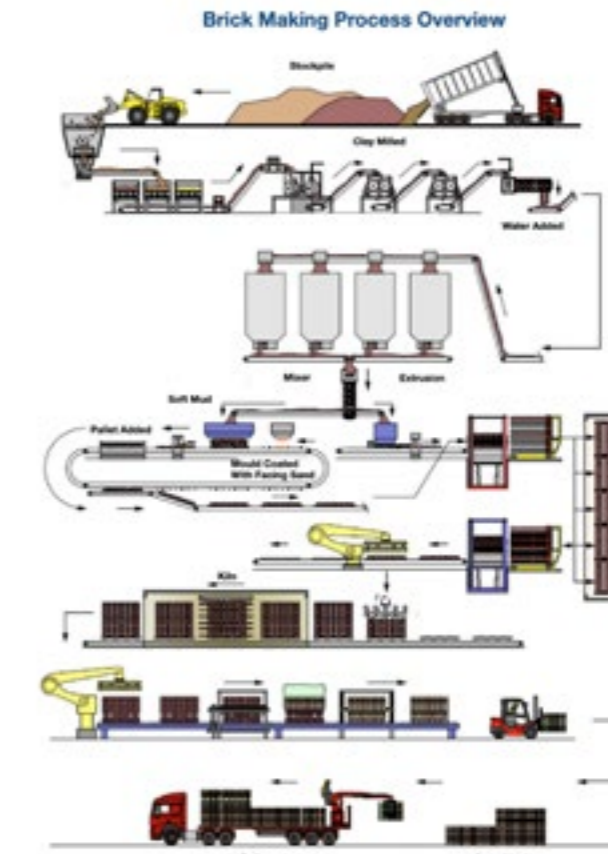

Fig.01 - Brick Production Process

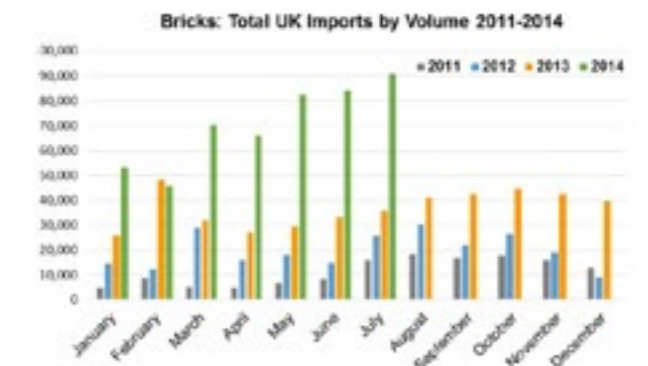

Fig.02 - UK Brick Imports between 2011 and 2014

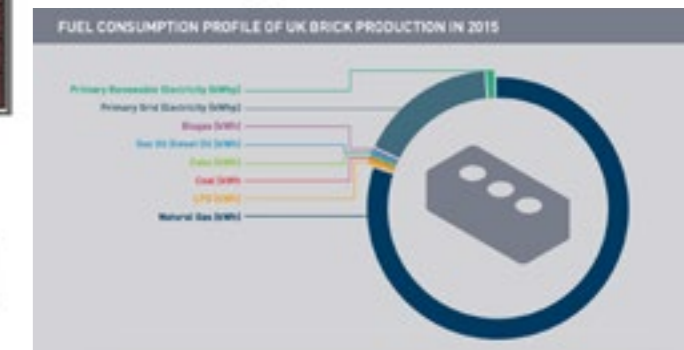
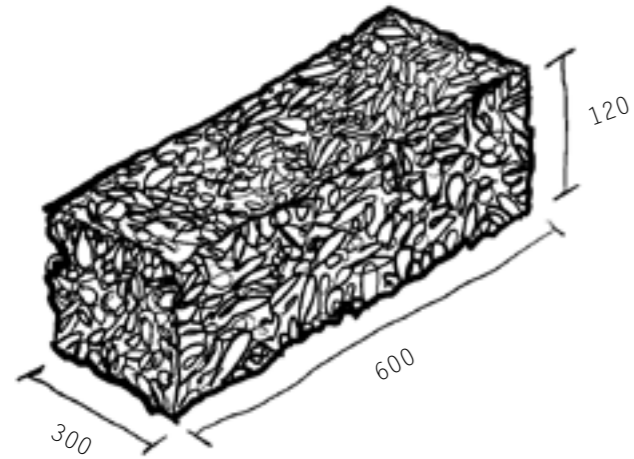

Fig.03 - Brick Production Fuel Consumption Diagram

CARBON

0.2 THE PROBLEM WITH HEMPCRETE



HEMP BRICK

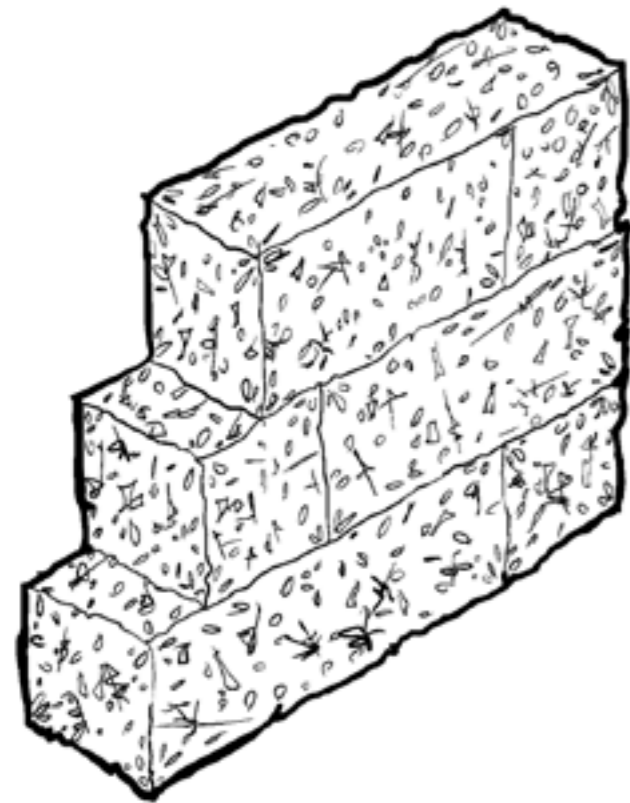

HEMP BRICK WALL

ADVANTAGES

Fast and Easy Building: Hemp bricks are very efficient in building durable walls, very quickly.

Thermal Resistance: Hemp bricks have good thermal resistance, making them a good choice for insulation purposes.

Weight: Hemp bricks are lighter when compared to regular clay bricks, due to the fact that they are less dense.

Bio-material: Hemp bricks are made out of Hemp, which is a plant based product, resulting in a carbon negative end product.

DISADVANTAGES

Material Cost: Hemp bricks are up to 16 times more expensive than a regular brick, resulting in contractors avoiding it.

Compressive Strength: Hemp bricks don't have enough compressive strength to make them a suitable and efficient construction material.

Main Product Issue: Hemp is grown specifically to make Hempcrete out of it. Entire fields are occupied with Hemp plants which are later processed to make Hempcrete.



Fig.04 - Hemp Field

BIO...?

0.3 THE SOLUTION OF SUGARCRETE

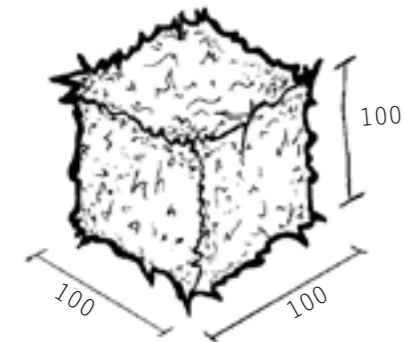

SUGARCRETE BRICK

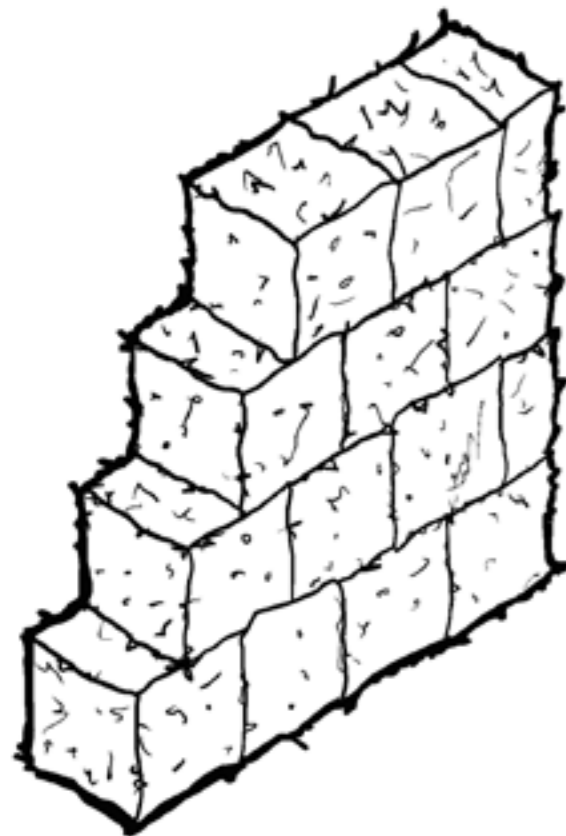

SUGARCRETE BRICK
WALL

ADVANTAGES

Waste Product: Sugarcrete is made using Bagasse, which is a byproduct of Sugar Cane processing.

Bio-material: Just like Hempcrete, Sugarcrete is a plant based product and has a negative carbon footprint value.

Weight: Sugarcrete has very low density, resulting in light bricks that can easily be transported, making it very efficient in building.

Bio-material: Hemp bricks are made out of Hemp, which is a plant based product, resulting in a carbon negative end product.

Compressive Strength: Sugarcrete bricks have good compressive strength, making them suitable for low-rise construction.

Thermal Resistance: Sugarcrete bricks have good thermal resistance, making them a good choice for insulation purposes.

Ease of Manufacturing: Sugarcrete bricks are easy to manufacture on or off site, making them suitable for an efficient brick substitute.

Circular Economy Potential: Since Bagasse is a byproduct of Sugar Cane production, Sugarcrete has a potential to create a circular economy in the countries that grow Sugar Cane.



Fig.05 - Sugarcrete

BIO.

0.4 THE COMPARISON

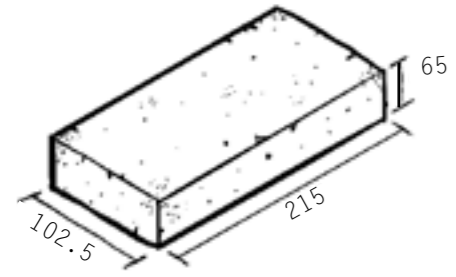

REGULAR UK BRICK

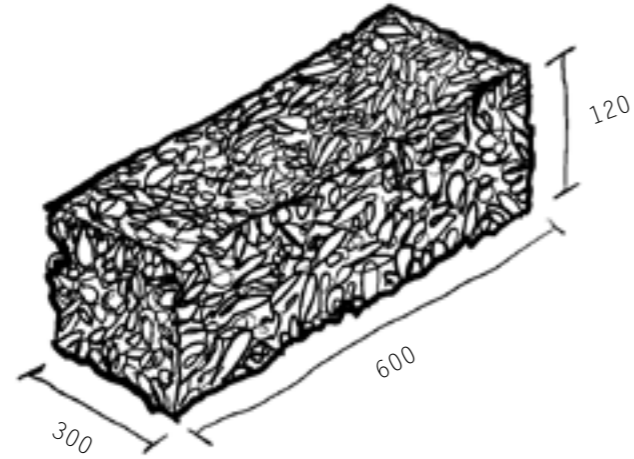

HEMP BRICK

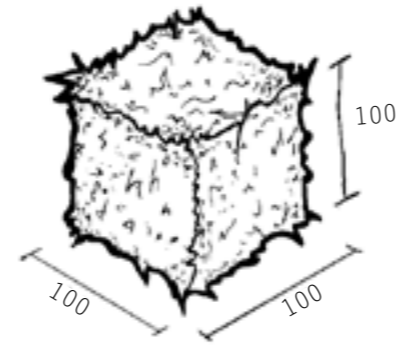

SUGARCRETE BRICK

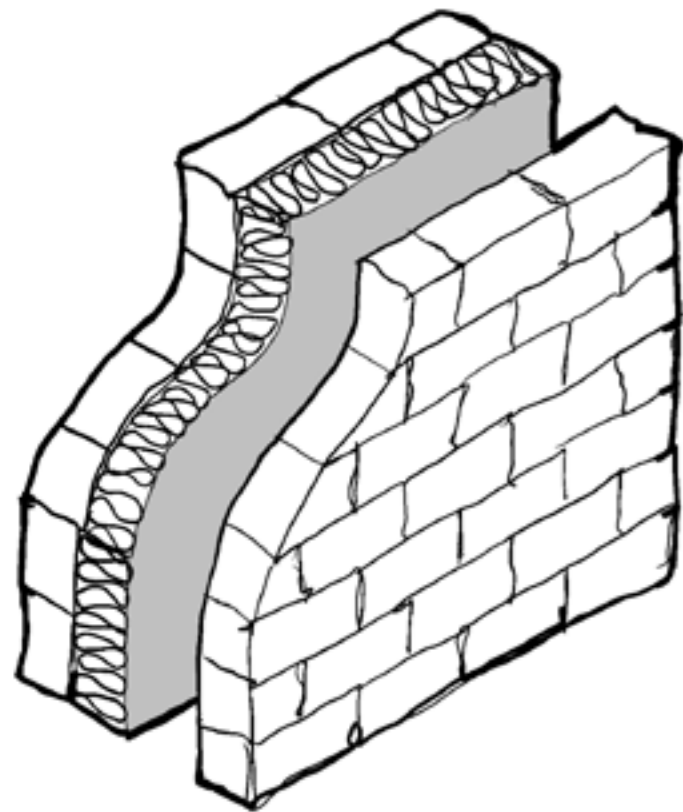

REGULAR UK BRICK WALL

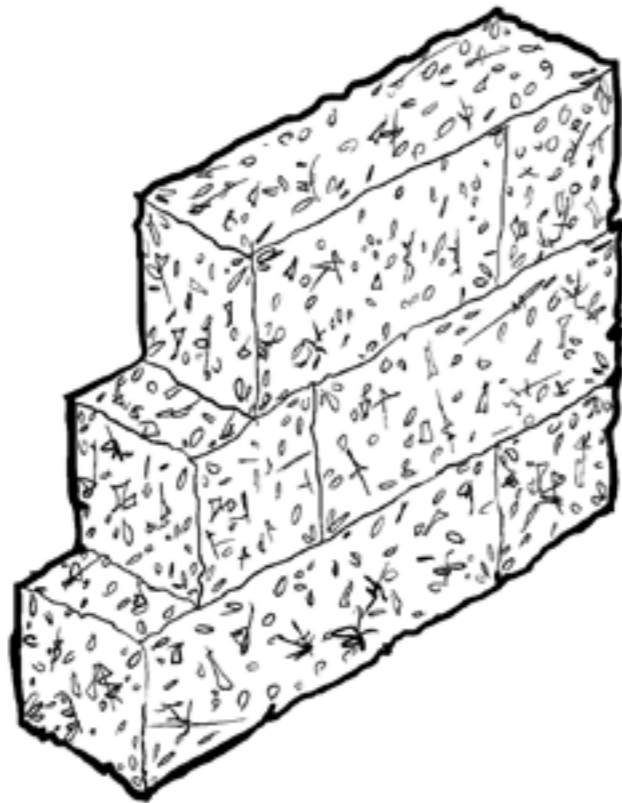

HEMP BRICK WALL

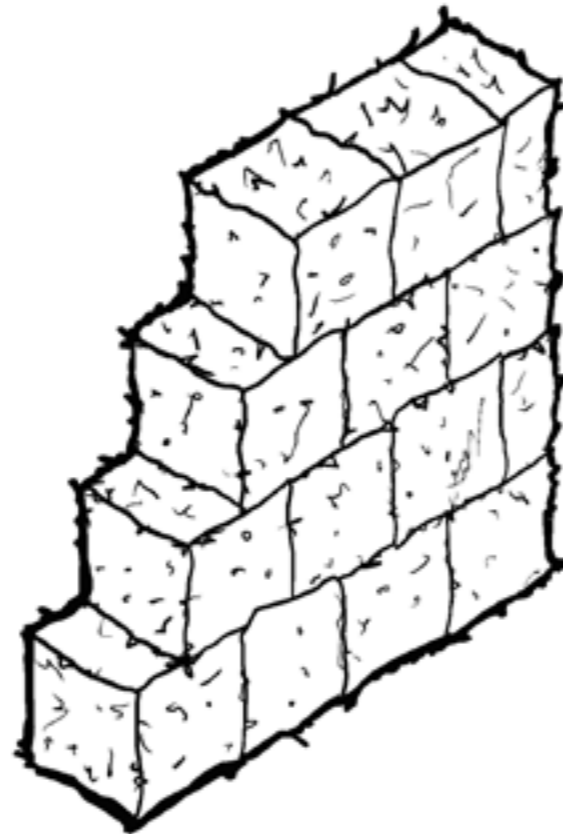

SUGARCRETE BRICK WALL

	Regular Brick	Hempcrete	Sugarcrete
Dimensions (mm)	65 x 215 x 102.5	120 x 600 x 300	100 x 100 x 100
U Value (W/mK)	0.025	0.071	0.065
Fire Resistance (min)	60 - 240	60	60
Compressive Strength (kN/m ²)	11200	1000	2760
Carbon Footprint (kgCO _e)	0.63	-0.165	-0.061
Weight: Amount (kg)	2.60	10	0.445
Unit Cost (£)	0.54	8.76	-

Notes: We used Michelmersh Bricks for the Regular Bricks, Hempbuild's 120 mm Hempcrete Blocks for Hempcrete, and our testing results for Sugarcrete.

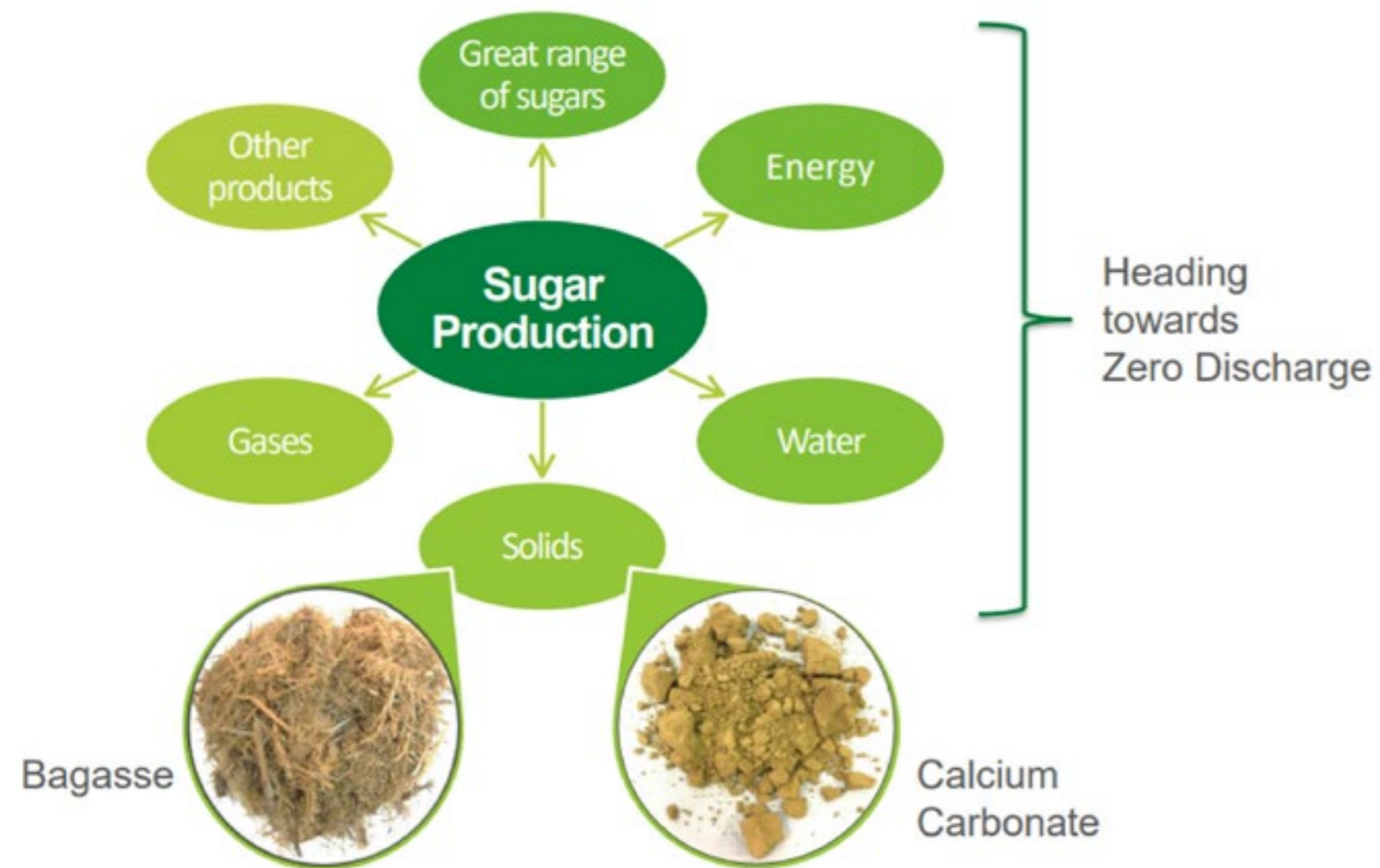

Fig.01 - Diagram 1

1.0 INTRODUCTION:

1.0a **Sugar Cane:** Sugar cane refers to a variety of tall perennial grass species and hybrids used for sugar production. The plants are 2-6 m tall, with robust, jointed, fibrous stalks that are high in sucrose, which accumulates in the internodes of the stalks. The grass family includes sugarcanes. It is endemic to India, Southeast Asia, and New Guinea, where it grows in warm, temperate tropical climates.

Tate & Lyle: Tate & Lyle are a part of the ASR Group which is according to their website, “the largest vertically integrated cane sugar producer in the world and foremost refiner of sugar”. They work with and are supplied by 18 countries determined by European Union Trade, such as: Guadalupe, Jamaica, Honduras, Belize, Guatemala, El Salvador, Nicaragua, Costa Rica, Brazil, Argentina, Guyana, Zambia, Malawi, Mozambique, Reunion, Zimbabwe, South Africa and Fiji.

Sugar Cane Composition: Sugar Cane is mostly made out of water, according to Figure 01 by the Tate & Lyle presentation on “Sustainable Raw Sugar Sourcing”, Sugar Cane consists of %73 Water and Impurities, %15 Fiber, and lastly, %12 Sucrose. The %12 Sucrose is used for refined sugar production. The %15 Fiber is also known as “Bagasse”, which is the dry pulpy fibrous material that remains after crushing sugarcane stalks. Bagasse consists of %2 Soil, %2 Sucrose, %48 Water and most importantly, %48 Fiber.

By-products: Other by-products of the Sugar Cane refinery process according to ASR Group presentation “Innovation Driven Sustainability... Sustainability Driven Innovation” are Water, Gases, Energy, and Solids such as Bagasse and Calcium Carbonate, also known as CaCO₃. See Figure 02.

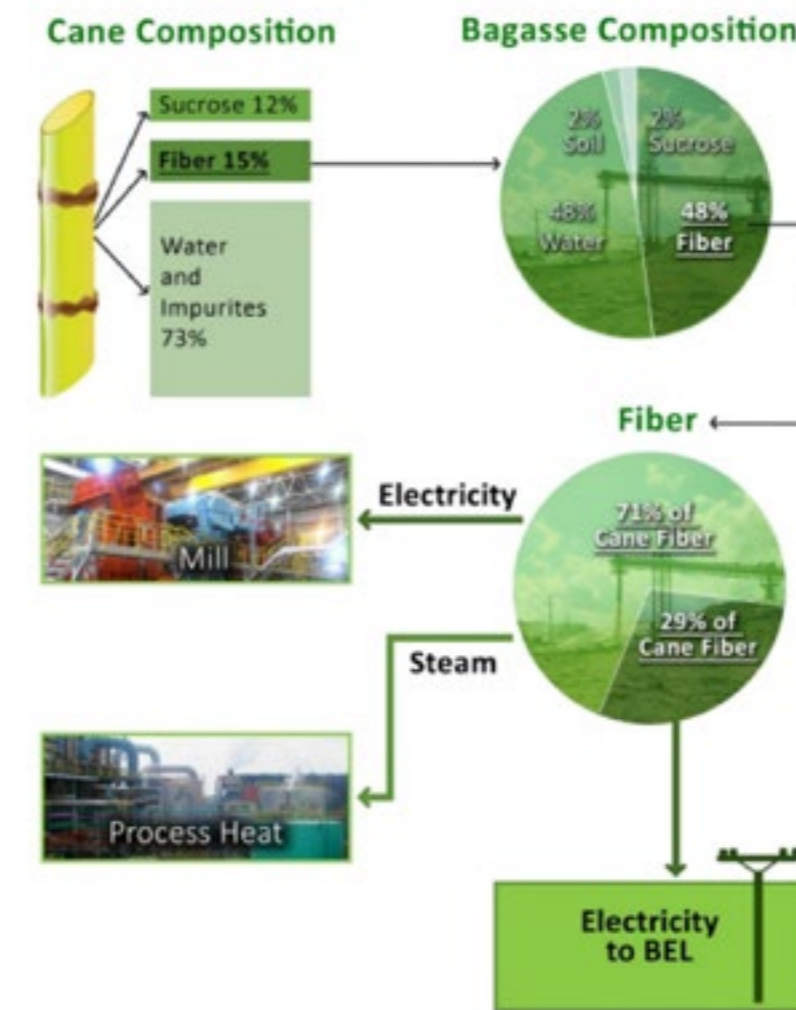

Fig.02 - Diagram 2

1.1 INTRODUCTION: PRODUCTION

1.1a

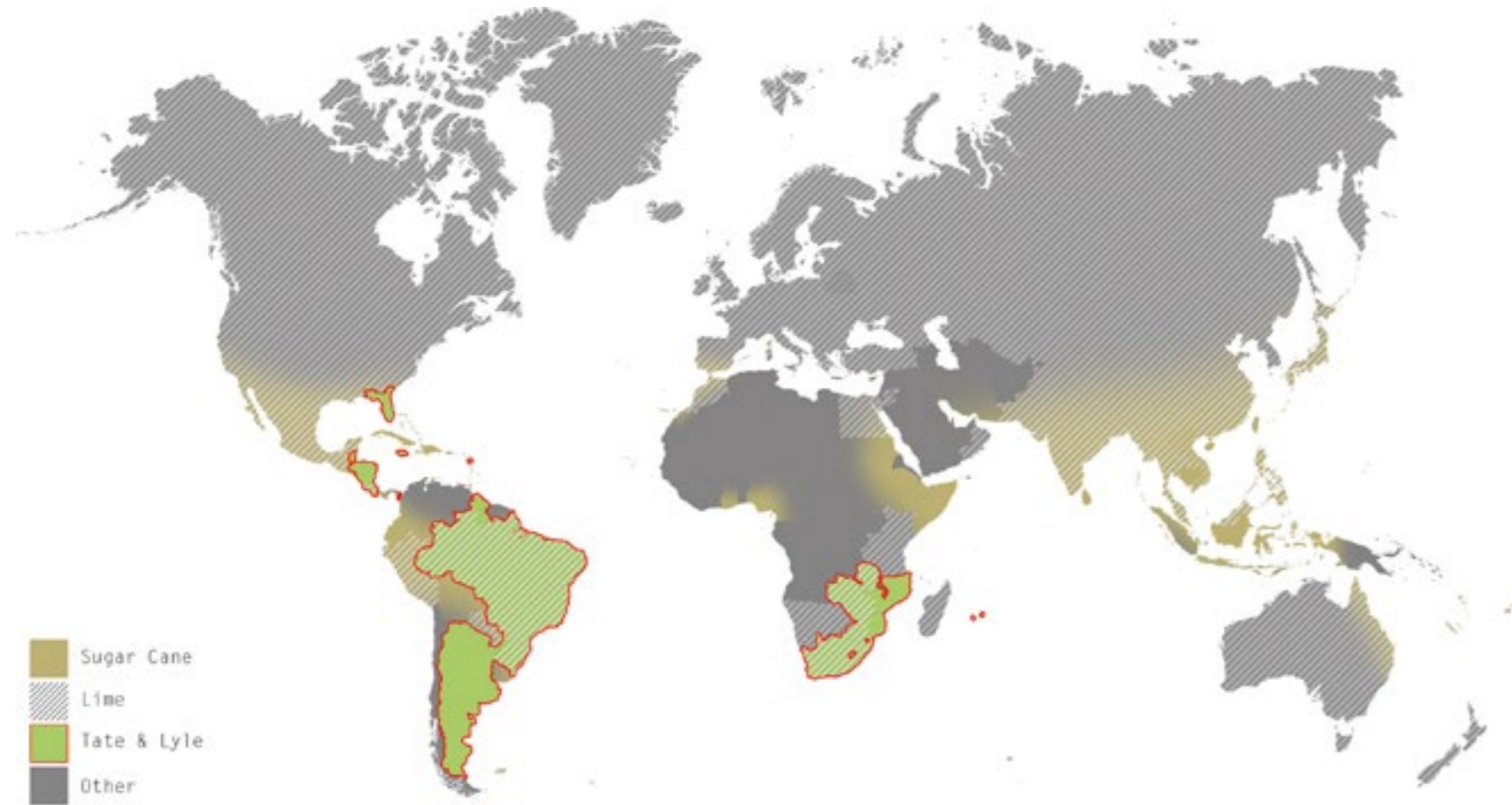

Fig.03 - Sugar Cane, Lime and Tate & Lyle Map

Plantations: The scale of the plantations and the refining of Sugar Cane depends on many factors which changes with each country. The climate, precipitation, manpower, economy, land, technology, socio-economical climate and even just the preferences of the supplying countries factor in heavily throughout the process. For example, the farms in Belize are comparably smaller than most of the other countries, even though the farmers have the potential to expand them. One of the reasons for this, is that the farmers fear they would run out of jobs if they moved on to higher technology equipment such as automatic harvesters, as Sugar accounts for 60% of Belize’s agricultural exports. (Northern Belize - The Sugar Industry in Northern Belize., n.d.)

Global South Economy: Most of these countries that grow Sugar Cane are located in the South Globe, and with our proposed methods of re-using and re-purposing Bagasse, these countries could get in on a circular economy which would benefit them economically and practically, because Sugarcrete is very simple to produce and use. Sugarcrete can be the next emerging market of the Global South.



Fig.04 - Cutting Sugar Cane

Delivery of Cane: The cut Sugar Cane is loaded onto delivery trucks and delivered to the Sugar Cane Mills where it will be further processed to create raw sugar.

Arrival to the Mill: The cut Sugar Cane is dumped into big containers which transfer the cut Sugar Cane towards the machinery where it will be crushed.

Crushing of Cane: The cut Sugar Cane is crushed and milled. The bagasse is transferred to the Power Station while the rest is clarified, resulting in raw sugar.



Fig.05 - Trucks

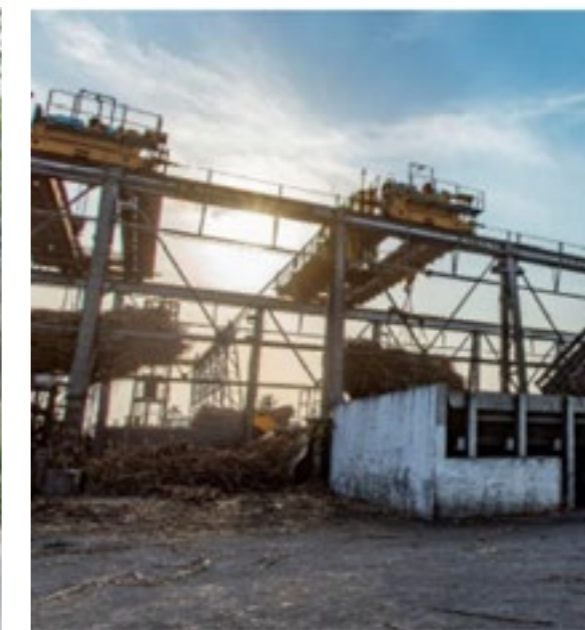

Fig.06 - Factory 1



Fig.07 - Factory 2

1.2 INTRODUCTION: PROCCESSING

1.2a

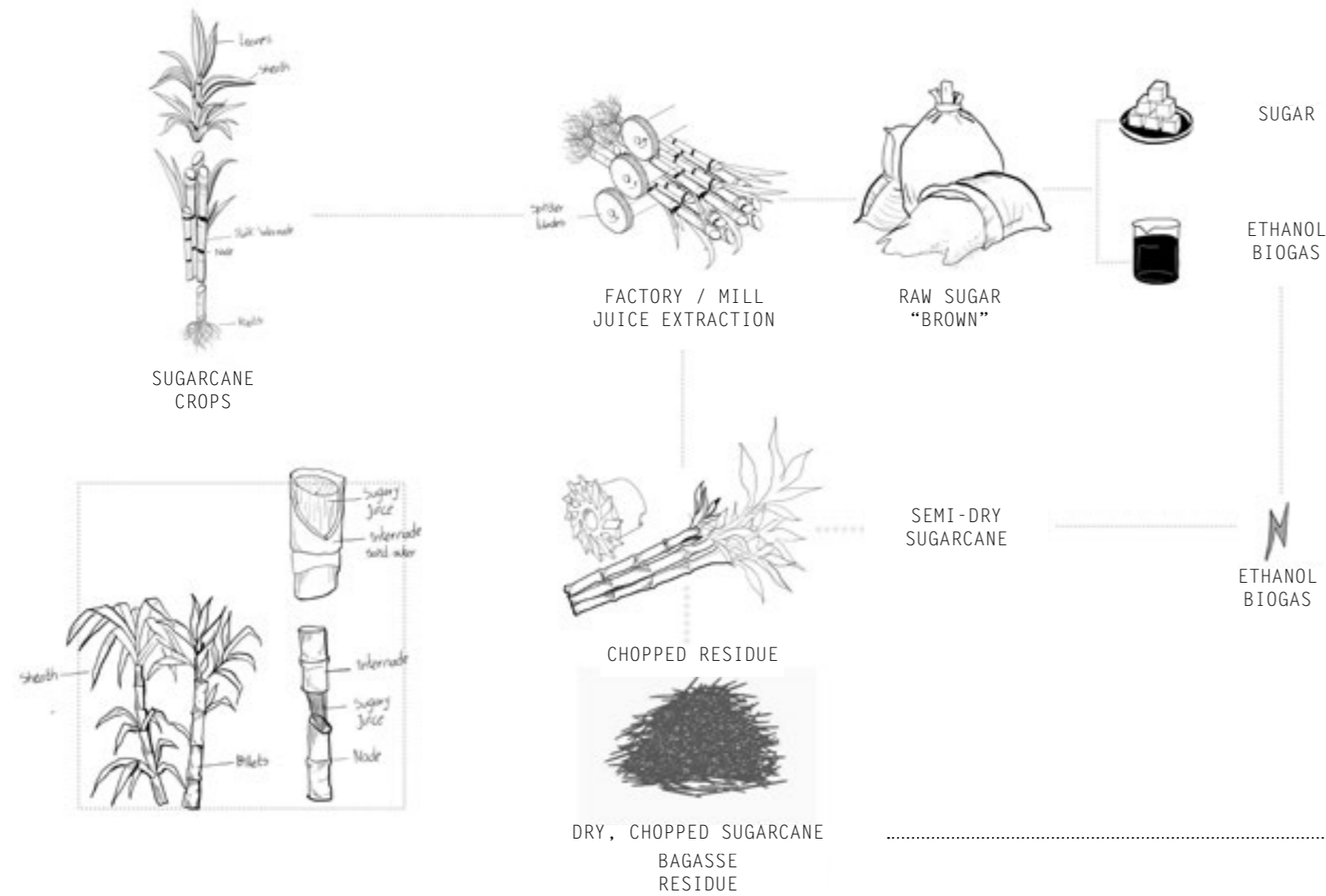
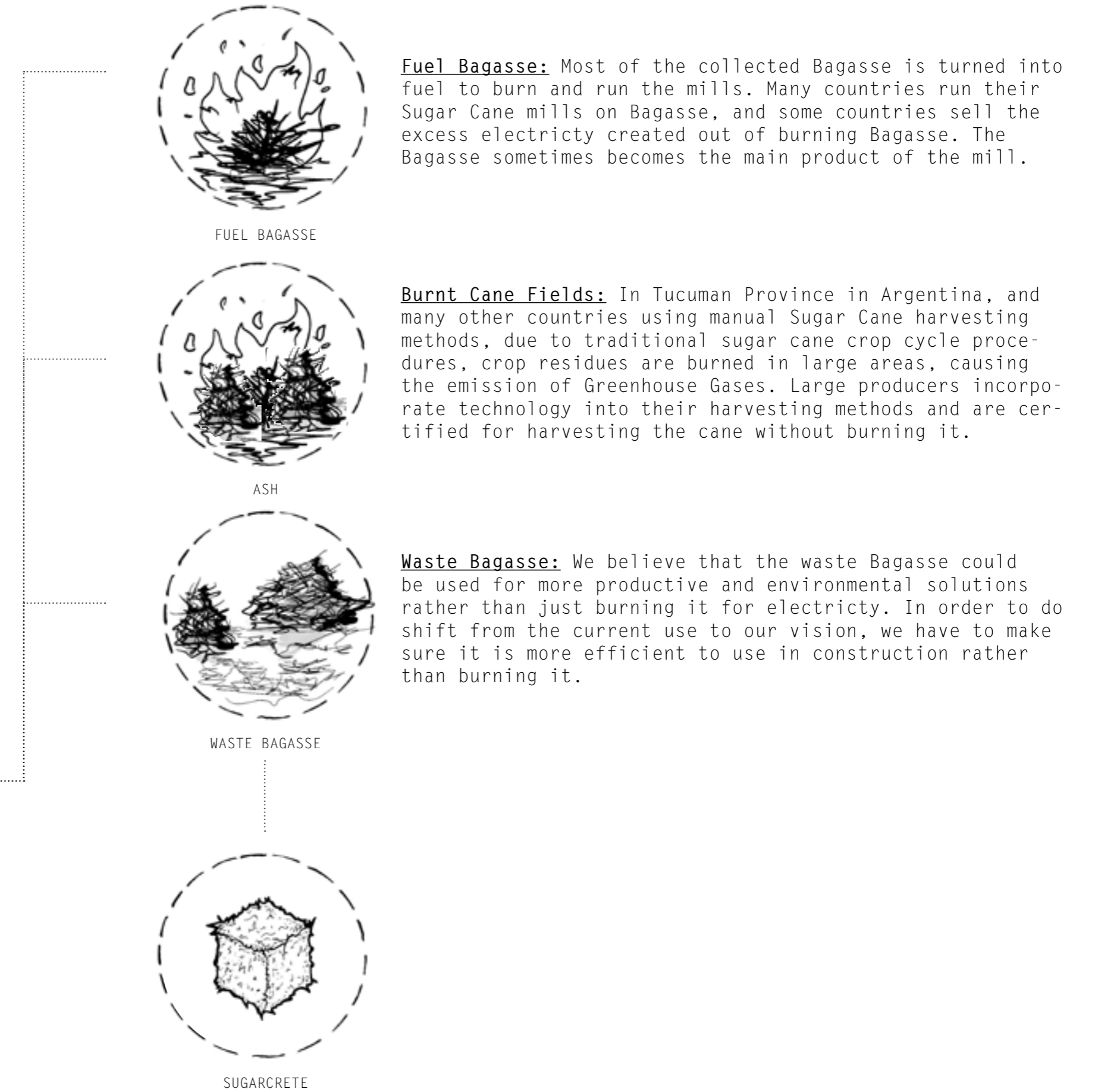

Fig.08 - Sketch

Processing of Cane: The processing of Cane consists of several steps showcased in this series of sketches. The Sugar Cane crops are cut and transported to the factory or mill where they are crushed for the extraction of their juice. The sugary juice is further processed for raw “brown” sugar to then create sugar and ethanol biogas. The chopped residue is further chopped to create Bagasse.



Fuel Bagasse: Most of the collected Bagasse is turned into fuel to burn and run the mills. Many countries run their Sugar Cane mills on Bagasse, and some countries sell the excess electricity created out of burning Bagasse. The Bagasse sometimes becomes the main product of the mill.

Burnt Cane Fields: In Tucuman Province in Argentina, and many other countries using manual Sugar Cane harvesting methods, due to traditional sugar cane crop cycle procedures, crop residues are burned in large areas, causing the emission of Greenhouse Gases. Large producers incorporate technology into their harvesting methods and are certified for harvesting the cane without burning it.

Waste Bagasse: We believe that the waste Bagasse could be used for more productive and environmental solutions rather than just burning it for electricity. In order to do shift from the current use to our vision, we have to make sure it is more efficient to use in construction rather than burning it.

2.0 MATERIALS

2.0a



Bagasse



Lime



Clay

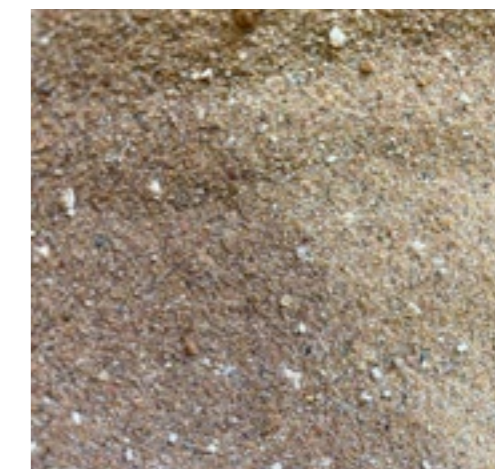

Sand

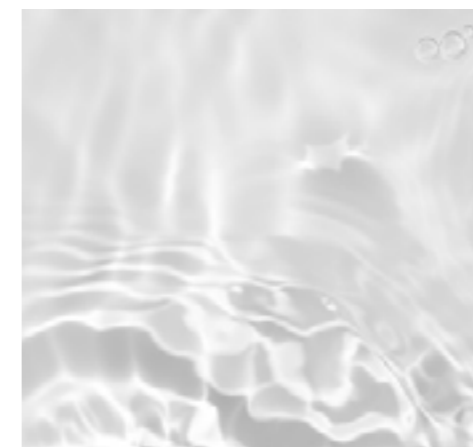

Water



Calcium Carbonate

Bagasse



Magnification x20.0



Magnification x200.0



Sugar cane refers to several species and hybrids of tall perennial grass in the genus *Saccharum*, tribe Andropogoneae, that are used for sugar production. The plants are 2-6m tall with stout, jointed, fibrous stalks that are rich in sucrose, which accumulates in the stalk internodes.

Bagasse is one of the main materials we have looked into in this process and experimenting the properties of it.

Bagasse is the dry pulpy fibrous material that remains after crushing sugarcane or sorghum stalks to extract their juice. It is used as a biofuel for the production of heat, energy, and electricity, and in the manufacture of pulp and building materials.

The images on the left is the bagasse taken from a microscope which gives us a visual of how the bagasse fibres still hold sugars in its fibres even after several processes.

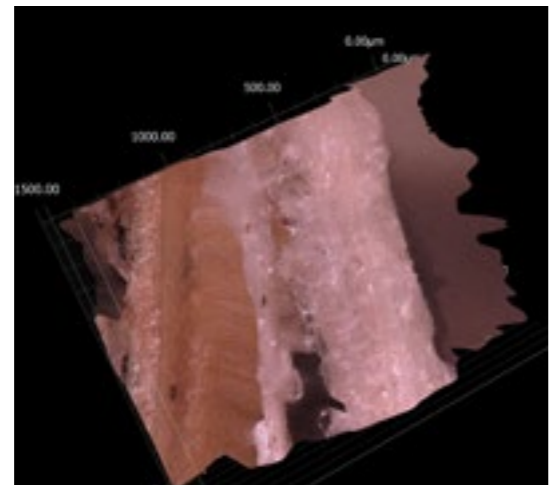

Magnification x100.0

Lime/Quicklime



Calcium oxide (CaO), commonly known as quicklime or burnt lime, is a widely used chemical compound. It is a white, caustic, alkaline, crystalline solid at room temperature. Both it and a chemical derivative (calcium hydroxide, of which quicklime is the base anhydride) are important commodity chemicals.

Quicklime has a wide range of uses, including in the production of iron and steel, paper and pulp production, treatment of water and flue gases and in the mining industry. For the iron and steel industry, we also supply different fractions of both reactive shaft furnace-burnt and hard-burnt rotary kiln lime.

Lime is a very reactive material used in the construction industry, we have used lime to mix with the bagasse and water as an adhesive to hold the bagasse in shape.

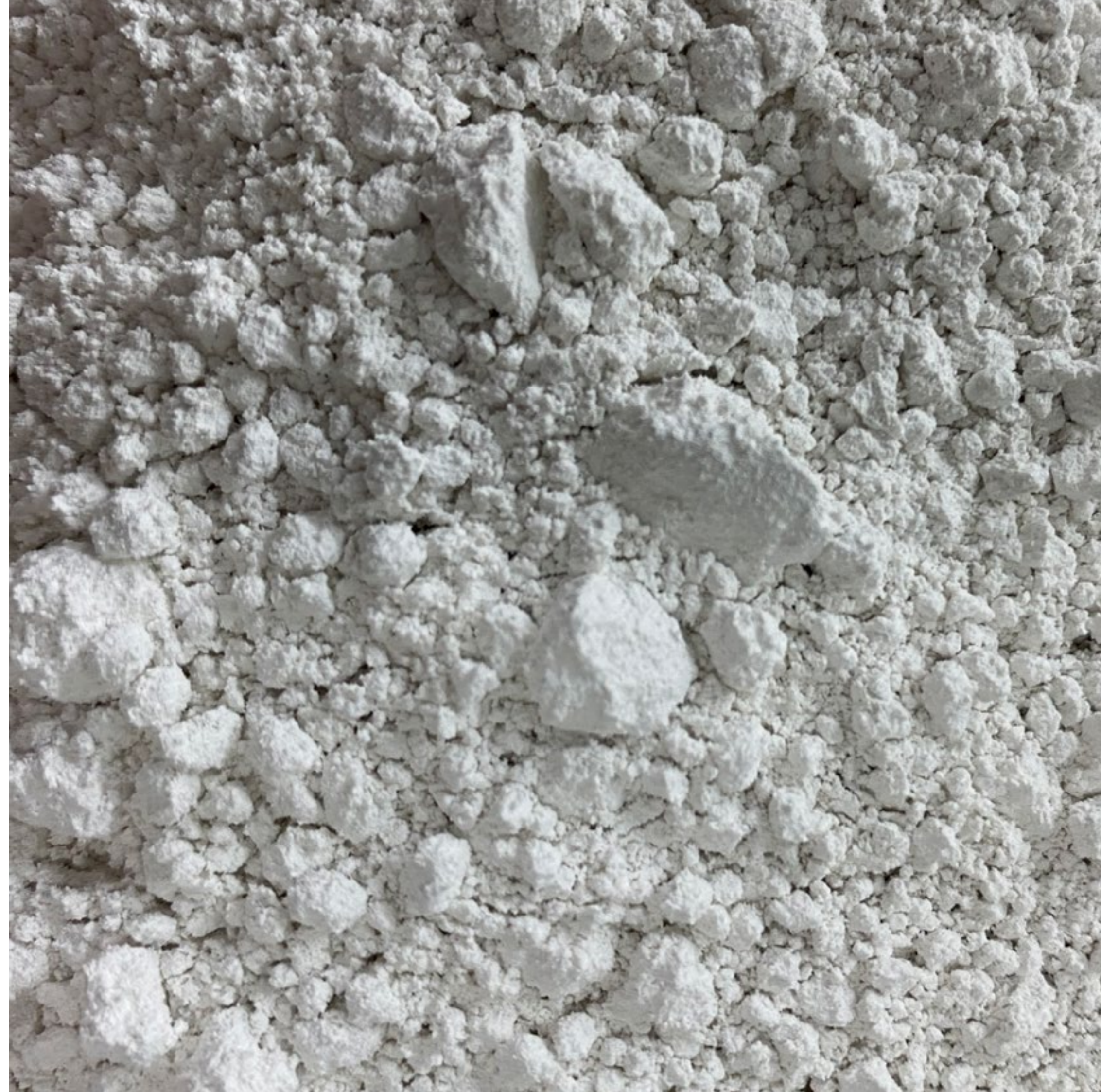

Clay

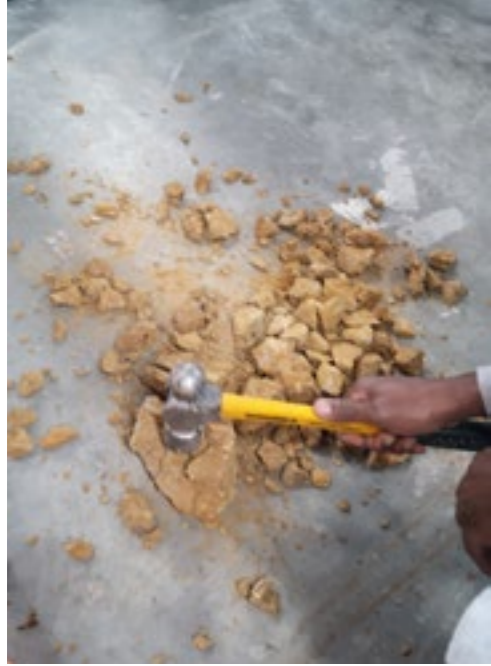

The London Clay is a stiff bluish clay which becomes brown when weathered and oxidized. Nodular lumps of pyrite are frequently found in the clay layers. Pyrite was produced by microbial activity (sulphate reducing bacteria) during clay sedimentation.

This clay was found at a construction site, close to the university. The clays was found mix with other elements such as concrete and sand.

Smashing down rocks of London clay into small pieces to wet it. Once the small rocks of clay is wet it slowly soaks up all the water and turns into muddy clay. We worked in different sections, part of us smashing the rocks and some soaking the tiny rocks in water and using their hands to speed up the process of removing any stones inside the rocks to have a smooth texture ready to mix in the bagasse.



Sand



Granular material composed of finely divided rock and mineral particles. Sand grains are smaller than gravel and coarser than silt.

Sand is very commonly used in construction, often providing bulk, strength, and stability to other materials such as asphalt, concrete, mortar, render, cement, and screed. Sand is used in liquid form to manufacture glass and is also used for moulding metal casting.

The purpose of the sand we used was to provide strength and stability mixing with the bagasse and clay.



Calcium Carbonate



Calcium carbonate is a chemical compound with the formula CaCO_3 . It is a common substance found in rocks as the minerals calcite and aragonite (most notably as limestone, which is a type of sedimentary rock consisting mainly of calcite) and is the main component of eggshells, snail shells, seashells and pearls.

Using calcium carbonate to experiment different material adding into the bagasse and lime mixture. The purpose of this was to see how well the lime will react with the calcium carbonate to improve its stability.



3.0 MANUAL GUIDE

3.1 Outcomes



1 - 8

The size of the cube brick is 10cm x 10cm x 10cm. Cubes shapes are made for experiments with a different mixture of materials, fire resistance test, and compression test.

9

This panel was made specifically for the U-Value test to evaluate the material's thermal resistance. The dimension of the panel fits perfectly in the thermal testing rack.

10 - 11

It is to be made in order to test how the material behaves in a large volume. The mold is made of reused wood and C&C cut geometry to test the flexibility of the material in an organic geometric pattern.

12 - 13

This prototype has a similar character as cube brick with the twist of organic pattern on one side. It is made to explore the materials in an organic geometric pattern in a small amount.

14

The cuboid-shaped panel is made to assess the elastic and compressive fracture properties of brittle materials or low-ductility materials.

3.2 Bagasse + Lime :



Step 1 : Make the mold.
We use recycled wood to make the mold. The size of the mold depends on the size of the panel needed. Cover the inside surface of the mold with oil.



Step 2 : Weight and prepare the material.
Weight and prepare the materials of water, lime & bagasse.



Step 3 : Mixture.
Mix the material thoroughly. Do mix the lime and water first, then add bagasse bit by bit. Let it mix for 1 minute or more.

Notes : These procedures was taken based on what was available at the time.



Step 4 : Pour mixture into the mold.
After the mixture is mixed thoroughly, pour the mixture into the mold. Tap/press down the mixture repeatedly to have a compact panel.



Step 5 : Let it dry.
After filling up the mold up to the level needed, leave it to dry for 3 days. Afterwards, gently remove the mold from the mixture to let it dry faster.



Step 6 : Complete
Ready to use.

3.3 Bagasse + Clay:



Step 1 : Make the mold.
We use recycled wood to make the mold. The size of the mold depends on the size of the panel needed. Cover the inside surface of the mold with oil.



Step 4 : Pour mixture into the mold.
After the mixture is mixed thoroughly, pour the mixture into the mold. Evenly spread the mixture into the mold.



Step 2 : Prepare the material.
We crushed and sift the clay for easy mixing. Prepare the materials of water, clay & bagasse.



Step 5 : Let it dry.
After filling up the mold up to the level needed, leave it to dry for 3 days. Afterward, gently remove the mold from the mixture to let it dry faster.



Step 3 : Mixture.
Mix the material thoroughly. Do mix the lime and water first, then add bagasse bit by bit. Let it mix for 1 minute or more.



Step 6 : Complete
Ready to use.

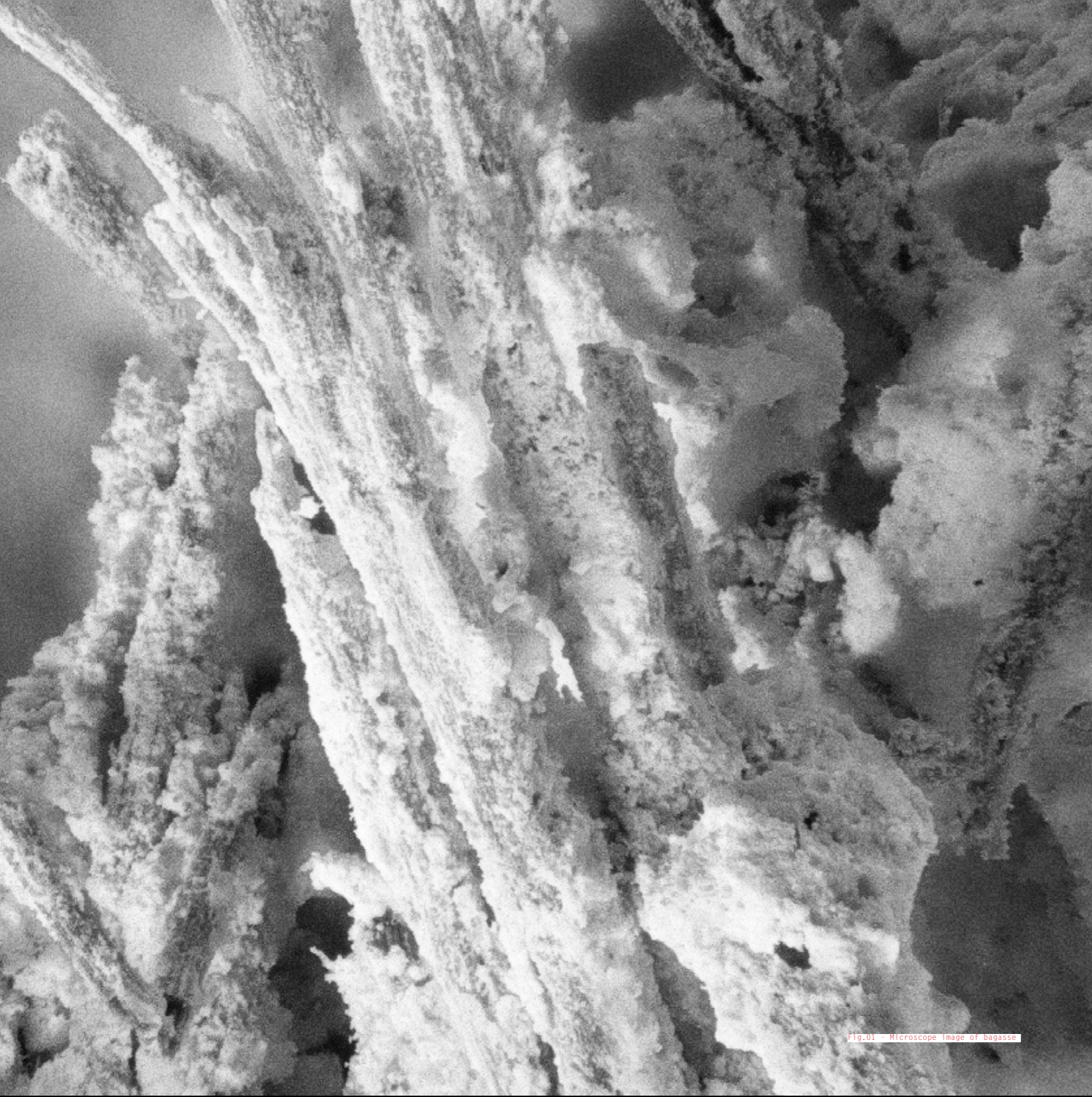

Fig.01 - Microscope image of bagasse

4.0 CARBON FOOTPRINT CALCULATIONS

Today, the term “carbon footprint” is often used as shorthand for the amount of carbon (usually in tonnes) being emitted by an activity or organization. The carbon footprint is also an important component of the Ecological Footprint, since it is one competing demand for biologically productive space. Carbon emissions from burning fossil fuel accumulate in the atmosphere if there is not enough biocapacity dedicated to absorb these emissions. Therefore, when the carbon footprint is reported within the context of the total Ecological Footprint, the tonnes of carbon dioxide emissions are expressed as the amount of productive land area required to sequester those carbon dioxide emissions. This tells us how much biocapacity is necessary to neutralize the emissions from burning fossil fuels. This framework also shows climate change in a greater context—one which unites all of the ecological threats we face today. Climate change, deforestation, overgrazing, fisheries collapse, food insecurity, and the rapid extinction of species are all part of a single, over-arching problem: Humanity is simply demanding more from the Earth than it can provide. By focusing on the single issue, we can address all of its symptoms, rather than solving one problem at the cost of another. Also, it makes the self-interest to act far more obvious.

The climate pact approved in Paris in December 2015 represented a huge historic step in re-imagining a fossil-free future for our planet. It is nothing short of amazing that nearly 200 countries around the world—including oil-exporting nations—agreed to keep global temperature rise well below 2 degrees Celsius and, to the surprise of many, went even further by agreeing to pursue efforts to limit the increase to 1.5 degrees above pre-industrial levels.

KEY WORDS

Embodied Carbon

is the sum of greenhouse gas emissions released associated with raw material extraction, manufacturing, and support transportation for material production and the emissions associated with the construction, maintenance, renovation, and end of life considerations of buildings and infrastructure.

CO₂e [carbon dioxide equivalent]

is a constant characteristic of a particular material. The corresponding greenhouse gas emissions are measured and summed together relative to their impact of one molecule of carbon dioxide and measured as carbon dioxide equivalent (CO₂e) with units of kilograms.

Carbon Footprint

can also be used to discuss operational carbon requirements, for example heating and lighting of a building, or operation of a power tool.

Sequestered CO₂

is the value that indicates the CO₂ that has been sequestered by the material. It is a negative value as it is sequestered and not released, and calculated like this: Embodied carbon * %Sequestered CO₂. [%Sequestered CO₂ is a speculative value]

4.1 PROTOTYPES

1.0 Quicklime	: 325 g
Bagasse	: 90 g
Water	: 650 g
TOTAL CF	: 0.020 kgCO_e



2.0 Quicklime	: 325 g
Bagasse	: 120 g
Water	: 650 g
TOTAL CF	: -0.029 kgCO_e



3.0 Quicklime	: 325 g
Bagasse	: 140 g
Water	: 650 g
TOTAL CF	: -0.061 kgCO_e



4.1 PROTOTYPES

4.0 Quicklime	: 300 g
Limestone	: 300 g
Bagasse	: 90 g
Water	: 750 g
TOTAL CF	: 0.008 kgCO_e



5.0 Quicklime	: 300 g
Limestone	: 300 g
Bagasse	: 120 g
Water	: 750 g
TOTAL CF	: -0.029 kgCO_e



6.0 Clay	: 325 g
Sand	: 150 g
Bagasse	: 140 g
Water	: 650 g
TOTAL CF	: -0.172 kgCO_e



4.2 NOTES & CALCULATIONS

QUICKLIME

-**Sequestered CO₂** = Embodied carbon * %Sequestered CO₂ = 1.16 * 60% = 0.696 (which is considered a negative value because it is a sequestered CO₂)

-**Carbon Footprint** = can be calculated in two ways:

a) (Embodied Carbon + Sequestered CO₂) * Quantity = (1.16 - 0.696) * 0.325 = 0.1508 kgCO₂e

b) Embodied Carbon * % Sequestered CO₂ * Quantity = 1.16 * 40% * 0.325 = 0.1508 kgCO₂e

LIMESTONE

-**Sequestered CO₂** = limestone is Calcium carbonate, found in nature as CaCO₃, and does not sequestered CO₂ anymore.

BAGASSE

The case of bagasse is different from quicklime: the Embodied Carbon of bagasse is calculated independently from the sequestered CO₂.

-**Carbon Footprint (1)** = Embodied Carbon * Quantity = 0.0275 * 0.14 = 0.00385 kgCO₂e

This is the CO₂ that has been released by one block of bagasse during production. However bagasse derives from sugarcane and has been sequestering CO₂ since the time the sugarcane was being grown. For this reason we borrowed the sequestered CO₂ value of hemp (-1.84), which we believe to be comparable to the one of bagasse, to calculate the following:

-**Carbon Footprint (2)** = Sequestered CO₂ * Quantity = -1.84 * 0.14 = - 0.2576 kgCO₂e

This is the CO₂ that has been sequestered by the bagasse (via the sugarcane) prior to production (during growth).

-**Total Carbon Footprint** = Carbon Footprint (1) + Carbon Footprint (2) = 0.00385 - 0.2576 = -0.25375 kgCO₂e

This value is negative because the amount of CO₂ sequestered by the bagasse/sugarcane in the plantation, during growth, is by far greater than the CO₂ released during production, making bagasse an extremely eco-friendly material.

WATER

-**Sequestered CO₂** = tap water sequestered CO₂ is so little that is negligible.

LIMESTONE, CLAY, SAND, WATER

-**Carbon Footprint** = Embodied Carbon * Quantity.

FRAME

-**Sequestered CO₂** = as a convention the frame is said to be able to last for up to 1000 uses, making any sequestered CO₂ very minimal to the point that this value can be completely disregarded.

-Quantity

Void dimension (this is the void dedicated for the casting of the bagasse) : h= 0.1m ; w= 0.1m ; d=0.1m
Overall Block dimension [this includes the void and the frame] : h= 0.112m ; w=0.124m ; d=0.124m. [frame is 0.012m thick and has no top cover]

Frame Volume = Overall Block Volume - Void Volume = 0.00172211 - 0.001 = 0.00072211 m³

4.2 NOTES & CALCULATIONS

ELECTRICITY

-**Embodied Carbon** = 0.76 for every 1.0kWh
1.2kWh x 0.76 = 0.912 Embodied Carbon for 1 hour

-**Carbon Footprint** = Each bagasse mixture was mixed for at least 2 minutes, so we need to divide the Embodied Carbon of 1 hour by 30.
0.912 per h / 30 = 0.0304 for 2 min of mixing

TRANSPORTATION - FACTORY TO SITE

We are assuming that all materials, apart from quicklime, are available at insignificant distant, therefore the transport in this case is in function of quicklime.

-**Embodied Carbon transport** (tonnes km) = is the CO₂ released by the means of transport when it carries for a km a tonne of a particular material. this value is the same for all carried materials.

Embodied Carbon transport (tonnes km) needs to be converted into (kg km) = 0.17 / 1000 = 0.00017 kg km = is the CO₂ released by the means of transport when it carries for a km a kg of a particular material.

-**Carbon Footprint** = Embodied Carbon Transport * Distance * Quantity = 0.00017 * 50 * 0.325 = 0.0027625 kg km



Fig.02 - Bagasse & Quicklime bricks



Fig.03 - Bricks of different mixture

4.3 PROTOTYPE 1

1.0 Quicklime : 325 g
 Bagasse : 90 g
 Water : 650 g

CARBON FOOTPRINT

Quicklime : 0.1508 kgCO_e
 Bagasse : -0.1631 kgCO_e
 Water : 0.0005 kgCO_e
 Frame : 0.00046 kgCO_e
 Mixer : 0.0304 kgCO_e
 Transport : 0.0028 kgCO_e
TOTAL : 0.020 kgCO_e



4.3 PROTOTYPE 2

2.0 Quicklime : 325 g
 Bagasse : 120 g
 Water : 650 g

CARBON FOOTPRINT

Quicklime : 0.1508 kgCO_e
 Bagasse : -0.2175 kgCO_e
 Water : 0.0005 kgCO_e
 Frame : 0.00046 kgCO_e
 Mixer : 0.0304 kgCO_e
 Transport : 0.0028 kgCO_e
TOTAL : -0.029 kgCO_e



Input	Item	CO ₂ e (per kg)	Sequestered CO ₂ (per kg) [In the case of frame = amount of times frame will be used]	Quantity (kg)	Carbon Footprint (kgCO ₂ e)
Materials	Quicklime	1.16	-0.696	0.325	0.1508
	Limestone				
	Clay				
	Sand				
	Bagasse	0.0275	-1.84	0.09	-0.163125
	Water	0.0008		0.65	0.00052
	Frame (plywood, polystyrene and screws)	636	1000	0.00072	0.00045792
Electricity	Frame construction (sawing, drilling, etc)	Embodied Carbon	Number of mixing in 1 hour	Power of mixer (kWh)	kWh
	Bagasse-lime mixer	0.76	30	1.2	0.0304
Transportation-factory to	Material	Embodied Carbon transport (tonnes km)	Number of kg in 1 tonne	Distance (km)	kgkm
	Quicklime	0.17	1000	50	0.0027625
	Limestone				
	Bagasse				
TOTAL	Total Block Quantity / Wet Weight (kg)		Total Block Quantity / Dry Weight (kg) (after 2 weeks of drying)	Total Carbon Footprint per Wet Block (kg CO ₂ e)	Total Carbon Footprint in 1 kg of Wet Block [=Total Carbon Ft / Total Wet Weight]
	1.065			0.02181542	0.020483962

Input	Item	CO ₂ e (per kg)	Sequestered CO ₂ (per kg) [In the case of frame = amount of times frame will be used]	Quantity (kg)	Carbon Footprint (kgCO ₂ e)
Materials	Quicklime	1.16	-0.696	0.325	0.1508
	Limestone				
	Clay				
	Sand				
	Bagasse	0.0275	-1.84	0.12	-0.2175
	Water	0.0008		0.65	0.00052
	Frame (plywood, polystyrene and screws)	636	1000	0.00072	0.00045792
Electricity	Frame construction (sawing, drilling, etc)	Embodied Carbon	Number of mixing in 1 hour	Power of mixer (kWh)	kWh
	Bagasse-lime mixer	0.76	30	1.2	0.0304
Transportation-factory to	Material	Embodied Carbon transport (tonnes km)	Number of kg in 1 tonne	Distance (km)	kgkm
	Quicklime	0.17	1000	50	0.0027625
	Limestone				
	Bagasse				
TOTAL	Total Block Quantity / Wet Weight (kg)		Total Block Quantity / Dry Weight (kg) (after 2 weeks of drying)	Total Carbon Footprint per Wet Block (kg CO ₂ e)	Total Carbon Footprint in 1 kg of Wet Block [=Total Carbon Ft / Total Wet Weight]
	1.095			-0.03255958	-0.029734776

Fig.04 - Carbon Footprint: Q325/B90/W650

Fig.05 - Carbon Footprint: Q325/B120/W650

4.3 PROTOTYPE 3

3.0 Quicklime : 325 g
 Bagasse : 140 g
 Water : 650 g

CARBON FOOTPRINT

Quicklime : 0.1508 kgCO_e
 Bagasse : -0.25375 kgCO_e
 Water : 0.00052 kgCO_e
 Frame : 0.00046 kgCO_e
 Mixer : 0.0304 kgCO_e
 Transport : 0.0028 kgCO_e
TOTAL : -0.061 kgCO_e



Input	Item	CO ₂ e (per kg)	Sequestered CO ₂ (per kg) [In the case of frame = amount of times frame will be used]	Quantity (kg)	Carbon Footprint (kgCO ₂ e)
Materials	Quicklime	1.16	-0.696	0.325	0.1508
	Limestone				
	Clay				
	Sand				
	Bagasse	0.0275	-1.84	0.14	-0.25375
	Water	0.0008		0.65	0.00052
	Frame (plywood, polystyrene and screws)	636	1000	0.00072	0.00046
Electricity	Frame construction (sawing, drilling, etc)	Embodied Carbon	Number of mixing in 1 hour	Power of mixer (kWh)	kWh
	Bagasse-lime mixer	0.76	30	1.2	0.0304
Transportation-factory to	Material	Embodied Carbon transport (tonnes km)	Number of kg in 1 tonne	Distance (km)	kgkm
	Quicklime	0.17	1000	50	0.0027625
	Limestone				
	Bagasse				
TOTAL	Total Block Quantity / Wet Weight (kg)		Total Block Quantity / Dry Weight (kg) (after 2 weeks of drying)	Total Carbon Footprint per Wet Block (kg CO ₂ e)	Total Carbon Footprint in 1 kg of Wet Block [=Total Carbon Ft / Total Wet Weight]
	1.115			-0.06880958	-0.061712628

4.3 PROTOTYPE 4

4.0 Quicklime : 300 g
 Limestone : 300 g
 Bagasse : 90 g
 Water : 750 g

CARBON FOOTPRINT

Quicklime : 0.1392 kgCO_e
 Limestone : 0.00171 kgCO_e
 Bagasse : -0.1631 kgCO_e
 Water : 0.0006 kgCO_e
 Frame : 0.00046 kgCO_e
 Mixer : 0.0304 kgCO_e
 Transport : 0.0025 kgCO_e
TOTAL : 0.008 kgCO_e



Input	Item	CO ₂ e (per kg)	Sequestered CO ₂ (per kg) [In the case of frame = amount of times frame will be used]	Quantity (kg)	Carbon Footprint (kgCO ₂ e)
Materials	Quicklime	1.16	-0.696	0.3	0.1392
	Limestone	0.00571		0.3	0.001713
	Clay				
	Sand				
	Bagasse	0.0275	-1.84	0.09	-0.163125
	Water	0.0008		0.75	0.0006
	Frame (plywood, polystyrene and screws)	636	1000	0.00072	0.00046
Electricity	Frame construction (sawing, drilling, etc)	Embodied Carbon	Number of mixing in 1 hour	Power of mixer (kWh)	kWh
	Bagasse-lime mixer	0.76	30	1.2	0.0304
Transportation-factory to	Material	Embodied Carbon transport (tonnes km)	Number of kg in 1 tonne	Distance (km)	kgkm
	Quicklime	0.17	1000	50	0.00255
	Limestone				
	Bagasse				
TOTAL	Total Block Quantity / Wet Weight (kg)		Total Block Quantity / Dry Weight (kg) (after 2 weeks of drying)	Total Carbon Footprint per Wet Block (kg CO ₂ e)	Total Carbon Footprint in 1 kg of Wet Block [=Total Carbon Ft / Total Wet Weight]
	1.44			0.01179592	0.008191611

Fig.06 - Carbon Footprint: Q325/B140/W650

Fig.07 - Carbon Footprint: Q300/L300/B90/W750

4.3 PROTOTYPE 5

5.0 Quicklime : 300 g
 Limestone : 300 g
 Bagasse : 120 g
 Water : 750 g



CARBON FOOTPRINT

Quicklime : 0.1392 kgCO₂e
 Limestone : 0.00171 kgCO₂e
 Bagasse : -0.2175 kgCO₂e
 Water : 0.0006 kgCO₂e
 Frame : 0.00046 kgCO₂e
 Mixer : 0.0304 kgCO₂e
 Transport : 0.0025 kgCO₂e
TOTAL : -0.029 kgCO₂e

Input	Item	CO ₂ e (per kg)	Sequestered CO ₂ (per kg) [In the case of frame = amount of times frame will be used]	Quantity (kg)	Carbon Footprint (kgCO ₂ e)
Materials	Quicklime	1.16	0.696	0.3	0.1392
	Limestone	0.00571		0.3	0.001713
	Clay				
	Sand				
	Bagasse	0.0275	-1.84	0.12	-0.2175
	Water	0.0008		0.75	0.0006
	Frame (plywood, polystyrene and screws)	636	1000	0.00072	0.00045792
Electricity	Frame construction (sawing, drilling, etc)	Embodied Carbon	Number of mixing in 1 hour	Power of mixer (kWh)	kWh
	Bagasse-lime mixer	0.76	30	1.2	0.0304
Transportation-factory to site	Material	Embodied Carbon transport (tonnes km)	Number of kg in 1 tonne	Distance (km)	kgkm
	Quicklime	0.17	1000	50	0.00255
	Limestone				
	Bagasse				
TOTAL	Total Block Quantity / Wet Weight (kg)		Total Block Quantity / Dry Weight (kg) (after 2 weeks of drying)	Total Carbon Footprint per Wet Block (kg CO ₂ e)	Total Carbon Footprint in 1 kg of Wet Block [=Total Carbon Ft / Total Wet Weight]
	1.47			-0.04257908	-0.028965361

4.3 PROTOTYPE 6

6.0 Clay : 325 g
 Sand : 150 g
 Bagasse : 140 g
 Water : 650 g



CARBON FOOTPRINT

Clay : 0.0032 kgCO₂e
 Sand : 0.00171 kgCO₂e
 Bagasse : -0.2538 kgCO₂e
 Water : 0.0005 kgCO₂e
 Frame : 0.00046 kgCO₂e
 Mixer : 0.0304 kgCO₂e
 Transport : 0 kgCO₂e
TOTAL : -0.172 kgCO₂e

Input	Item	CO ₂ e (per kg)	Sequestered CO ₂ (per kg) [In the case of frame = amount of times frame will be used]	Quantity (kg)	Carbon Footprint (kgCO ₂ e)
Materials	Quicklime				
	Limestone				
	Clay	0.00991		0.325	0.00322075
	Sand	0.0114		0.15	0.00171
	Bagasse	0.0275	-1.84	0.14	-0.25375
	Water	0.0008		0.65	0.00052
	Frame (plywood, polystyrene and screws)	636	1000	0.00072	0.00045792
Electricity	Frame construction (sawing, drilling, etc)	Embodied Carbon	Number of mixing in 1 hour	Power of mixer (kWh)	kWh
	Bagasse-lime mixer	0.76	30	1.2	0.0304
Transportation-factory to site	Material	Embodied Carbon transport (tonnes km)	Number of kg in 1 tonne	Distance (km)	kgkm
	Quicklime	0.17	1000	50	0
	Limestone				
	Bagasse				
TOTAL	Total Block Quantity / Wet Weight (kg)		Total Block Quantity / Dry Weight (kg) (after 2 weeks of drying)	Total Carbon Footprint per Wet Block (kg CO ₂ e)	Total Carbon Footprint in 1 kg of Wet Block [=Total Carbon Ft / Total Wet Weight]
	1.265			-0.21744133	-0.171890379

Fig.08 - Carbon Footprint: Q300/L300/B120/W750

Fig.09 - Carbon Footprint: C325/S150/B140/W650

5.0 FIRE TEST REPORT

5.0a Construction Week 2021
Workshop 2
Sugarcane Bagasse as construction material

Instructors : Armor Gutierrez
: Mark Sowden

Students : Rashmi Madagamage Gunat-
hilaka
: Svetoslav Georgiev
: Mihriban Ustun
: Hidayati Yazmin

Location of Test : UEL Clay Workshop

Date of Test : 7th October 2021

5.1 INTRODUCTION

5.1a The prototype is produced by UEL to learn about lime bagasse. This test is to learn about bagasse heat resistance property.

5.2 HYPOTHESIS

5.2a The lime bagasse will not combust in high heat or high temperature.

5.3 SAFETY MEASURES

5.3a Wear the fire rated jacket, gloves and a face shield to while running the test.

5.3b Have a safe distance from the burning spot.

5.3c Be ready with equipment/tool/item to put out fire.

5.4 MATERIALS & EQUIPMENT

5.4a 4 prototypes



i. Prototype 1
Date of created : 10th June 2021
Water, Lime & Bagasse Ratio : 1:2:2



ii. Prototype 2
Date of created : 10th June 2021
Water, Lime & Bagasse Ratio : 1:2:3



iii. Prototype 3
Date of created : 15th June 2021
Water, Lime & Bagasse Ratio : 1:1:4



iv. Prototype 4
Date of created : 15th June 2021
Water, Lime & Bagasse Ratio : 1:1:3

- 4.2 Brazing Hearth Gas Fed
Temperature reached 1000 Degree Celsius



- 4.3 Brick



- 4.4 Timer

5.5 PROCEDURES

- 5.5a
- i. Place a brick at the table of brazing hearth gas fed
 - ii. Place the prototype on top of the brick
 - iii. Set timer for 7 Minute and 30 Second
 - iv. Switch on the torch
 - v. Point the torch to a spot of the prototype and start the timer for 7.5 minute
 - vi. Observe and collect data
 - vii. Record data at Minute 5 and Minute 7.5
 - viii. Switch off the torch after 7.5 minute
 - ix. Move the prototype from the table of brazing hearth gas fed

5.6 DATA RECORDING / RESULT / OBSERVATION

- 5.6a Prototypes after 5 minute burning time



Fig.01 - Prototype 1



Fig.02 - Prototype 2



Fig.03 - Prototype 3



Fig.04 - Prototype 4

5.6b Prototypes after 7.5 minute burning time



Fig.05 - Prototype 1



Fig.06 - Prototype 2



Fig.07 - Prototype 3



Fig.08 - Prototype 4

5.6c Close up view diameter of burn after 7.5 minute burning time

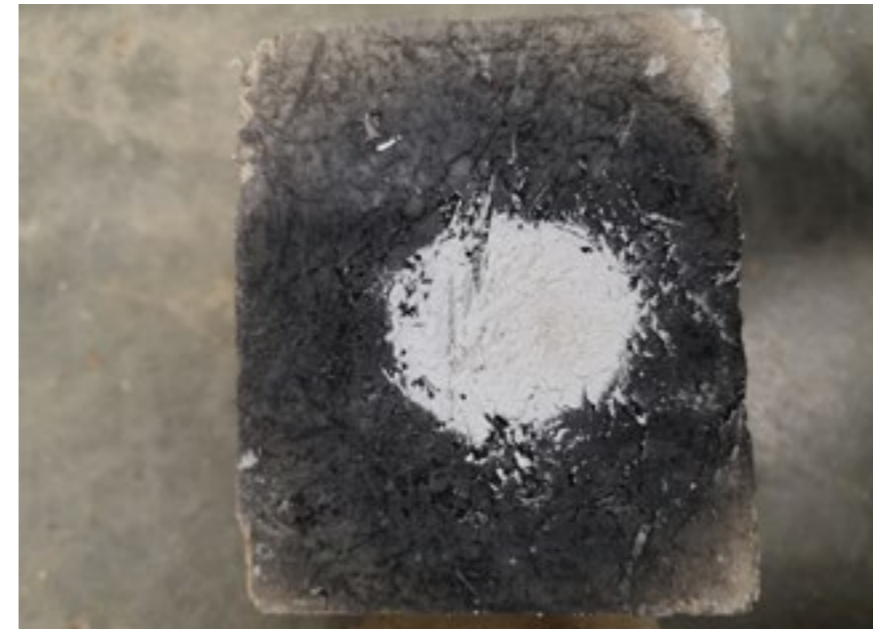

Fig.09 - Prototype 1

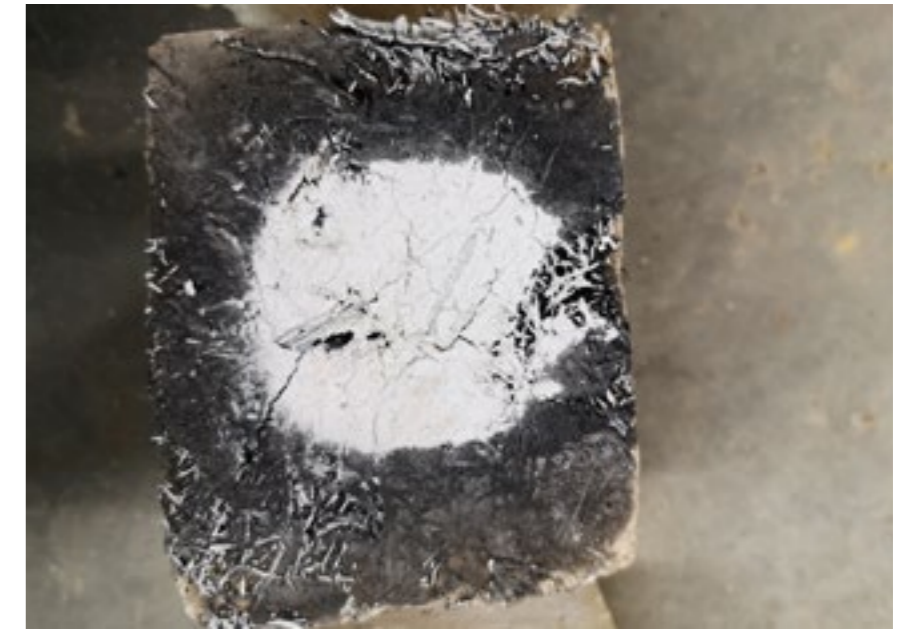

Fig.10 - Prototype 2

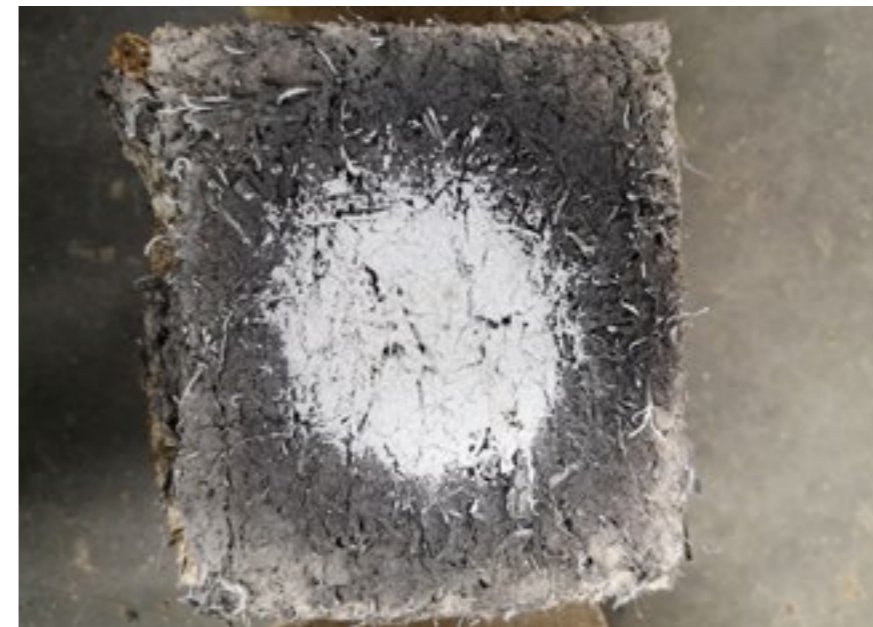

Fig.11 - Prototype 3

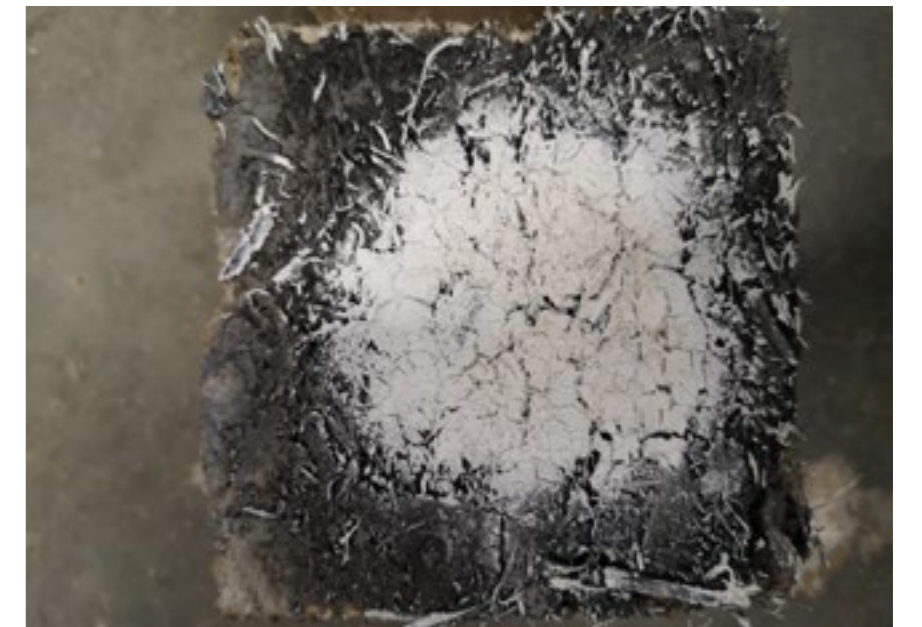

Fig.12 - Prototype 4

5.6d Description of burnt prototype

	Prototype 1	Prototype 2	Prototype 3	Prototype 4	Summary
Burning description for Minute 7.5	The surface slowly turns black. There is no crack developed. It takes 1 minute for a white mark to be seen. The heat was not spread easily.	The surface gradually turns black. There is no crack develop. It takes 45 seconds for a white mark to be seen. The heat was not spread easily.	The surface instantly turns black. There is no crack develop. It takes 30 seconds for a white mark to be seen. The heat was not spread easily.	The surface immediately turns black. There is no crack develop. It takes 15 seconds for a white mark to be seen. The heat was not spread easily.	The prototype with more lime was harder to burn.
Diameter of burnt spot	3cm. The smallest burning spot	4cm. A small burning spot	5cm. A big burning spot	7cm. The biggest burnt spot	The prototype with more lime have a smaller burning spot.
Condition of opposite surfaces	The opposite surface of burnt spot was at normal temperature				The prototype does not spread heat easily.
Strength of the prototype (Refer Chapter 6 : The compression test on)	Easiest to break (break at XX kN)	Medium to break (break at XX kN)	Hard to break (break at XX kN)	Hardest to break (break at XX kN)	The prototype with more lime breaks easier.

5.7 CONCLUSION

5.7a Bagasse lime does not combust in high temperature and high heat. The combination of bagasse and lime can withstand heat even at 900 to 1200 degree celcius. It is suitable to use as insulation material in construction.

The product of bagasse lime have a similar properties as hempcrete as a flame resistant. Hempcrete has a very low thermal conductivity and fire rating.

6.1 THERMAL RESISTANCE TEST REPORT

6.1a Tests were carried out in order to assess the material's thermal resistance properties, when compared to a manufactured 50mm thick expanded cork board with known thermal resistance properties.

The tool utilised was a bespoke plywood box with insulated walls, floor and cover. The test material is placed as a barrier in the middle of the box - separating the interior into a hot and a cold chambers. The hot chamber is equipped with 4no. 100W incandescent light bulbs, controlled via dimmer switches externally. The temperature in each box is measured with wired thermometers.



Thermal Testing Rack

As the light bulbs are turned on, increases in temperature in the hot and cold chambers are measured and compared, in order to evaluate the thermal conductivity of the test material.

A 75mm thick testing Sugarcrate Board (325g Lime / 675g Water / 80g Bagasse) was used in this experiment. It can be summarised that the board has a comparable thermal resistance to the 50mm cork board. Further tests need to be carried out in order to determine the precise thermal resistance of the board and the overall thermal conductivity of sugarcrate as a material.

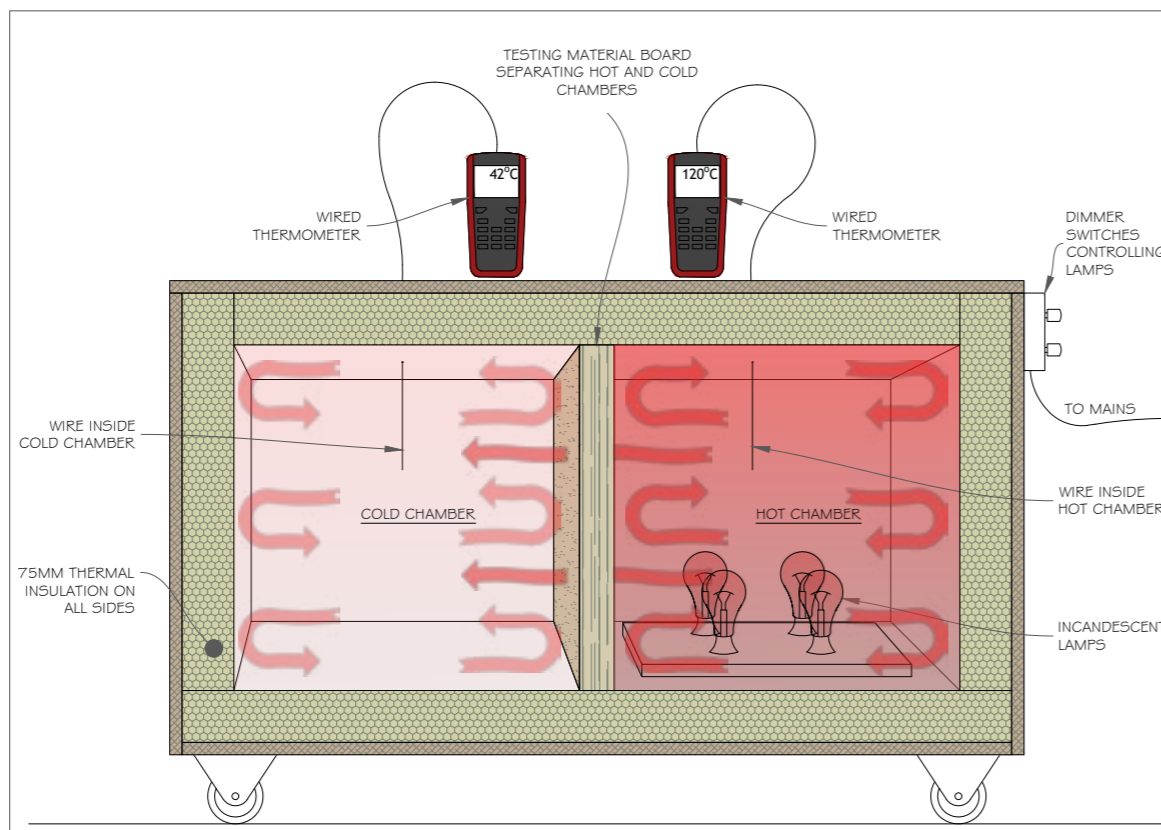

Thermal Testing Rack Diagram

50mm Cork Board Testing Results

Known Thermal Conductivity = 0.043W/m*K

d=50mm

$$K=Q*d/(A*\Delta T)$$

Solve for Q at t=40min

$$Q=K*A*\Delta T/d$$

$$Q=0.043*0.185*95/0.05$$

$$Q=15.11W - \text{heat transfer to the cold chamber}$$

$$R=L/K$$

$$R=0.05/0.043$$

$$R=1.16m^2K/W$$

75mm Sugarcrate Board Testing Results

The denser sugarcrate board absorbed and stored some of the heat energy, hence lower temperature was reached when compared to the cork test. At 100°C in the hot chamber, the sugarcrate passed a similar amount of heat energy (+1.6°C) into the cold chamber, to the cork (+1.5°C). This suggests that the two have similar thermal resistances. The sugarcrate board is 50% thicker than the cork board, hence it can be assumed that its thermal conductivity is 50% higher:

$$\text{Assumed } K = 1.5 * 0.043W/m*K = 0.065W/m*K$$

The thermal performance of sugarcrate of such mixing ratio would exceed that of typical masonry, but would be about 25% as effective as a typical rigid thermoset phenolic insulation board. Further tests need to be carried out in order to determine the precise thermal conductivity of the material.

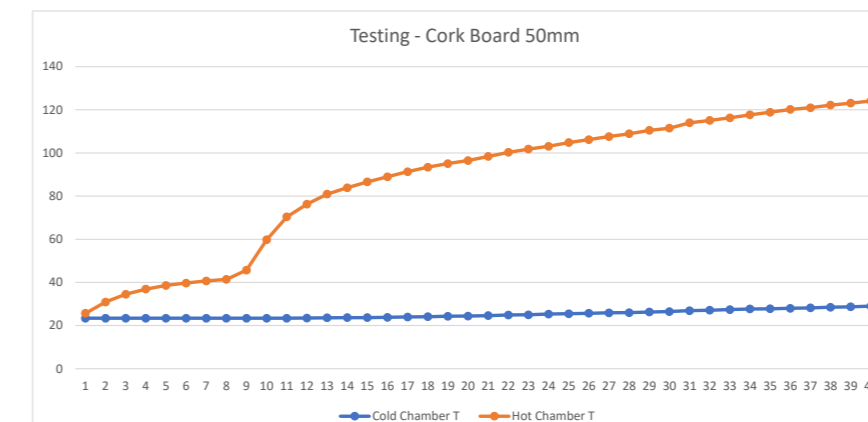

Expanded Cork Boards

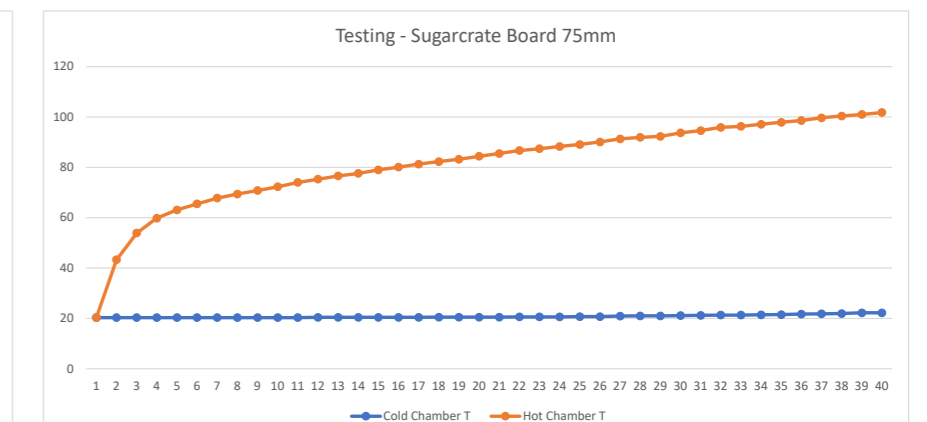

Sugarcrate Testing Board

6.2 COMPRESSIVE STRENGTH TEST REPORT

6.2a Compression tests involved manually applying compression onto four 100x100x100mm sample blocks of different mixture ratios, determining the force at which the blocks crack and at which they lose 20% of their volume.

The mixture ratios of each block in terms of volume were as follows:

Sample 1:
1 part Lime, 2 parts Water, 2 parts Bagasse

Sample 2:
1 part Lime, 2 parts Water, 3 parts Bagasse

Sample 3:
1 part Lime, 1 part Water, 3 parts Bagasse

Sample 4:
1 part Lime, 1 part Water, 4 parts Bagasse

In summary, the blocks exhibited bearing capacity lower than typical commercially available bricks and blocks. It appears that the higher the lime to bagasse ratio, the better compressive strength the block would have. The strongest mixture ratio, although lower in strength than a typical block, can still be considered comparable to blocks. Further research and experimentation may produce blocks of strengths equal to typical blocks.

Material Comparison			
	Material	Cracks at	20% Volume Loss at
	Typical Bricks	15.0-70.0 N/mm ²	N/A
	Typical Blocks	2.8-10.0 N/mm ²	N/A
Sugarcrate	1L / 2W / 2B	1.84 N/mm ²	2.76 N/mm ²
	1L / 2W / 3B	0.58 N/mm ²	1.15 N/mm ²
	1L / 1W / 3B	0.23 N/mm ²	1.27 N/mm ²
	1L / 1W / 4B	0.28 N/mm ²	0.58 N/mm ²



Compression Test Machine With Proving Ring



Sample 1 - Cracks



Sample 1 - Shrinkage

Test Sample 1

1L / 2W / 2B

Cracked at 1.84N/mm²

20% volume loss at 2.76N/mm²

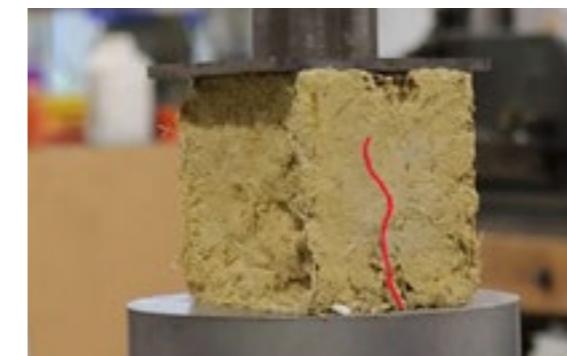

Sample 2 - Cracks



Sample 2 - Shrinkage

Test Sample 2

1L / 2W / 3B

Cracked at 0.58N/mm²

20% volume loss at 1.15N/mm²

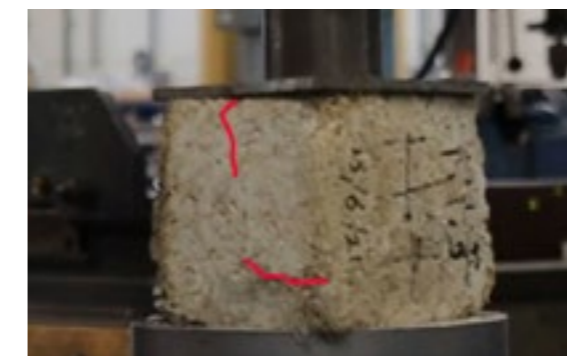

Sample 3 - Cracks

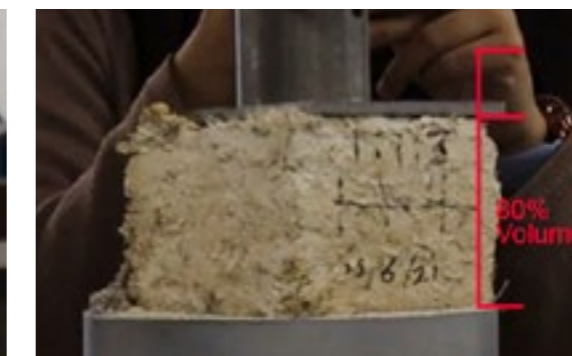

Sample 3 - Shrinkage

Test Sample 3

1L / 1W / 3B

Cracked at 0.23N/mm²

20% volume loss at 1.27N/mm²

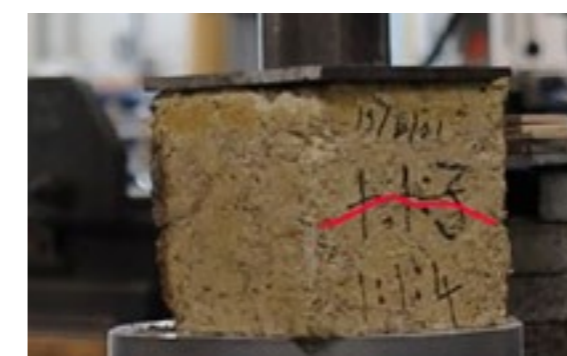

Sample 4 - Cracks



Sample 4 - Shrinkage

Test Sample 4

1L / 1W / 4B

Cracked at 0.28N/mm²

20% volume loss at 0.58N/mm²

7.0 WEATHERING TESTING

7.0a The breakdown of materials or components caused by interaction with water, atmospheric gases, and biological organisms is known as weathering. There are two types of weathering processes: physical weathering and chemical weathering.

The chemical response of water, atmospheric gases, and biologically generated compounds with rocks and soils is known as weathering.

Water is the primary cause of both physical and chemical weathering, while atmospheric oxygen and carbon dioxide, as well as the activities of living creatures, have a role.

Biological weathering is another name for chemical weathering caused by biological activities. Many landforms and landscapes on Earth are the consequence of weathering processes mixed with erosion and re-deposition.

The prototype has gone through the process of chemical weathering since June 2021. It was placed outdoor and exposed to the sun, rains and weather in London. The sequence of picture is to show the weathering of the prototype.



18th June 2021



26th October 2021



29th October 2021



31st October 2021



1st November 2021

8.1 PHOTO GALLERY



Prototype Key

Test Cube - 1
300L / 800W / 125B / 150CC

Test Cube - 2
300CL / 600W / 140B

Test Cube - 3
300L / 600W / 120B

Test Cube - 4
300L / 700W / 90B

Test Cube - 5
300CL / 600W / 140B

Test Cube - 6
300L / 600W / 140B

Test Cube - 7
300CL / 600W / 140B

Test Cube - 8
300CL / 600W / 140B TBC

Sample Board 75mm - 9
325L / 675W / 80B

In-situ Wall Sample - 10
325L / 675W / 80B

In-situ Wall Sample - 11
300CL / 600W / 140B

Aesthetic Cubes - 12
325L / 650W / 80B

Aesthetic Cubes - 13
325L / 650W / 80B

Sample Beam 500x100x100 - 14
325L / 675W / 80B









Prototypes 12 and 13 - Horizontal Patern - 325L / 650W / 80B



Prototype 9 - Thermal Insulation Board - 325L / 675W / 80B



Prototype 12 - 325L / 650W / 80B



Prototypes 12 and 13 - Horizontal Patern - 325L / 650W / 80B



Prototype 12 - 325L / 650W / 80B



Prototype 8 - 300C1 / 600W / 80B





Prototype 14 - Structural Beam - 325L / 675W / 80B



Prototype 9 - Thermal Insulation Board - 325L / 675W / 80B



Prototype 9 - Thermal Insulation Board - 325L / 675W / 80B



Prototype 14 - Structural Beam - 325L / 675W / 80B

8.2 SUMMARY OF TESTING



Chosen Prototype: We think the best working prototype from this testing and research process, was the prototype with the ratio of 1:1:3, (1 Lime, 1 Water, 3 Bagasse). We thought this prototype is in the sweet spot for the Lime:Bagasse mixture because with more lime, the prototype is stronger but cracks easier, and with more Bagasse the prototype is less strong but cracks less. This prototype still has room for improvement with further research and experimentation.

	Sugarcrete
Dimensions (mm)	100 x 100 x 100
U Value (W/mK)	0.065
Fire Resistance (min)	60
Compressive Strength (kN/m ²)	1270
Carbon Footprint (kgCO _e)	-0.029
Weight: Amount (kg)	0.445
Unit Cost (£)	-



9.1 BELIZE



9.1a Location: Belize is located on the mainland of Central America between 15°45' and 18°30' north latitude and 87°30' and 89°15' west longitude. The country is bordered by Mexico to the North, Guatemala to the West and South, and the Caribbean Sea to the East.

north to 160 inches (4064mm) in the south (Third National Communication, 2016). Other than South Africa, most countries, including Belize, are rainfed and do not require any further irrigation.

Climate & Precipitation: Mean temperature in Belize ranges from 27°C (max - 30.1°C, min 22.6°C) along the coast to 21°C (max - 25.3°C, min - 17.7°C) in the hills, with the coldest month being January and the warmest temperatures experienced in May. Alternatively, the rainy or hurricane season occurs from June to November and brings approximately 60 inches (1524mm) of rainfall in the

Conditions of Workers: In Belize, Sugar Cane field workers use manual cutters instead of modern equipment such as harvesters. This is mostly related with the size of the farms in Belize, and the fear of unemployment. Workers usually stay in established villages around the farms, and sometimes Palapas are used as community spaces within a village, or even as living units.

Belize: Bagasse, production (thousand metric tons)

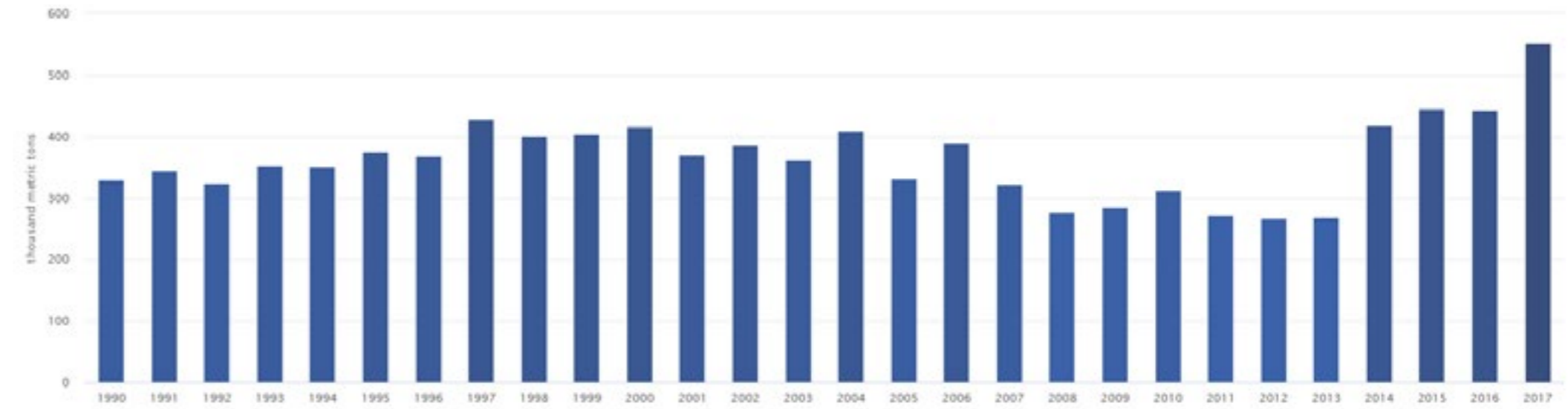

Fig.02 - Bagasse production in Belize

All countries: 2017 Bagasse, production (thousand metric tons)

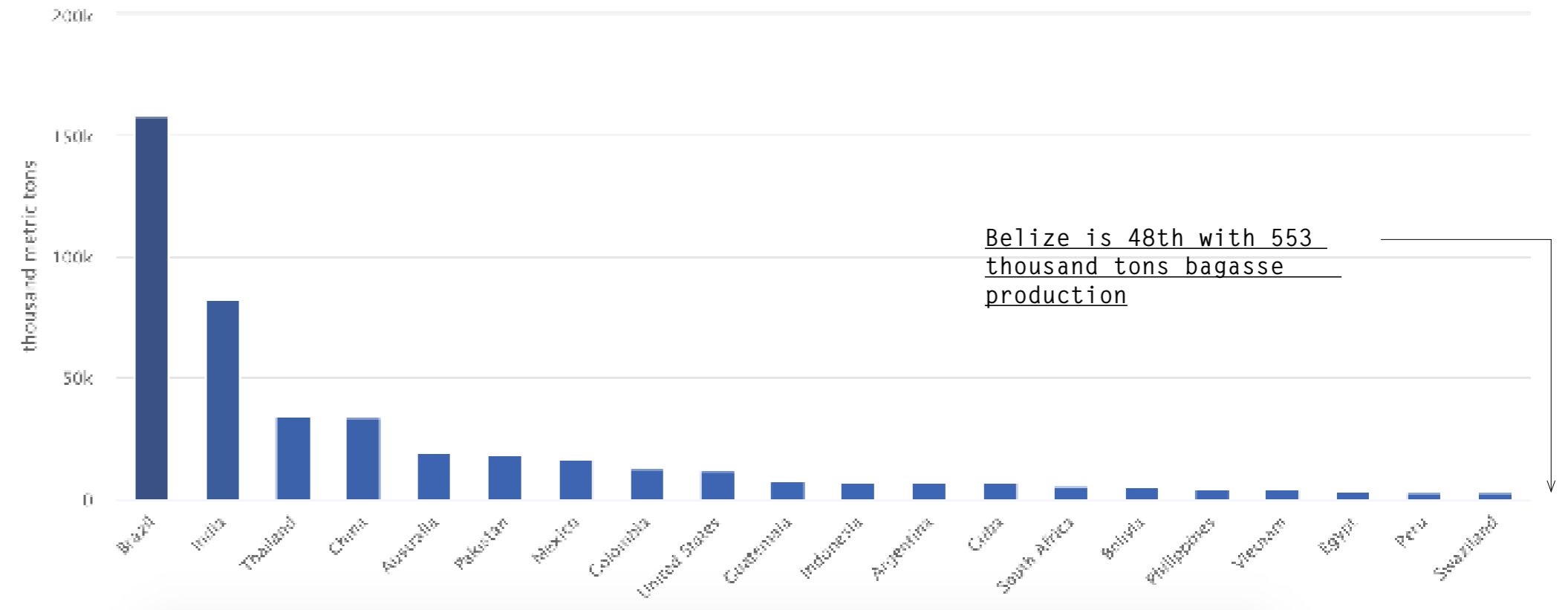

Fig.03 - Bagasse production in the world

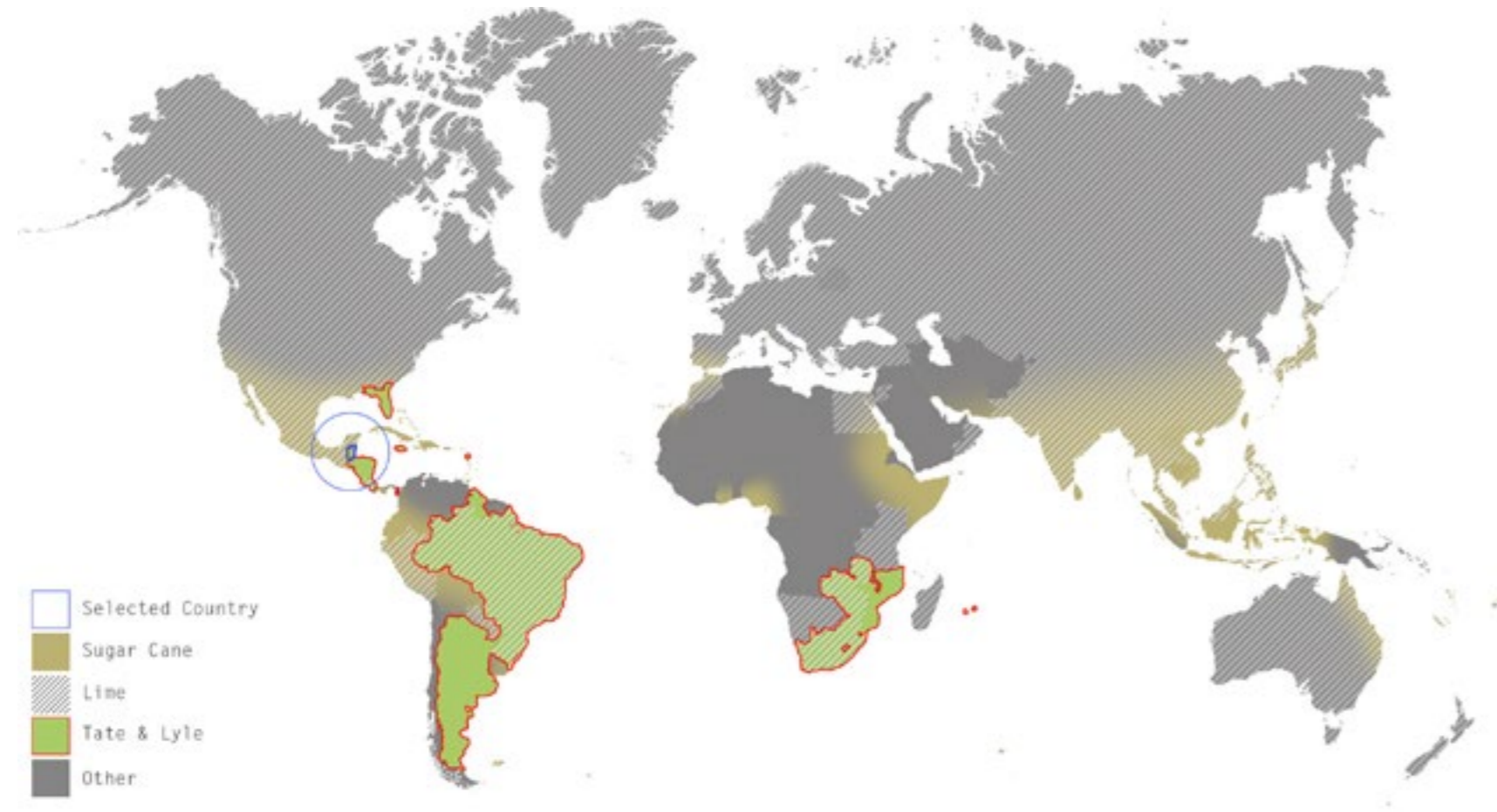

Fig.01 - Belize in World Map



9.1 BELIZE// the proposal



9.1b **Potential Problems:** Need for functional & established common gathering areas, storage spaces, shading elements and resting areas for Sugar Cane workers.

Potential Resources: Bagasse as a side/waste product of the Sugar Cane mills. Abundance of earth, clay and sand. Availability of on-site construction.

Potential Answers: Due to the harsh heat of Central America, sunshading elements and structures are a necessity for the Sugar Cane workers. For this reason, a structure that can satisfy the needs of shading, resting, gathering and socializing was aimed.

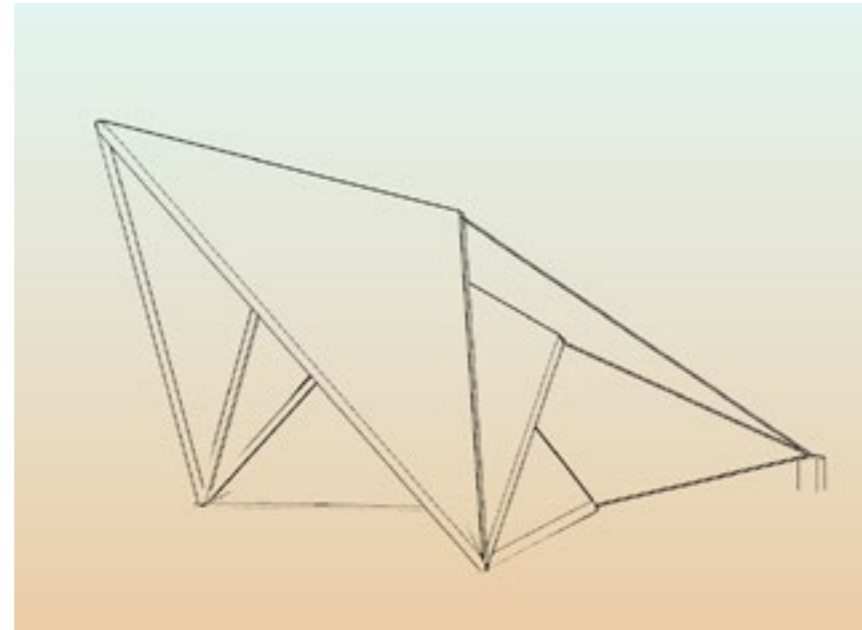

Fig.04 - Structure

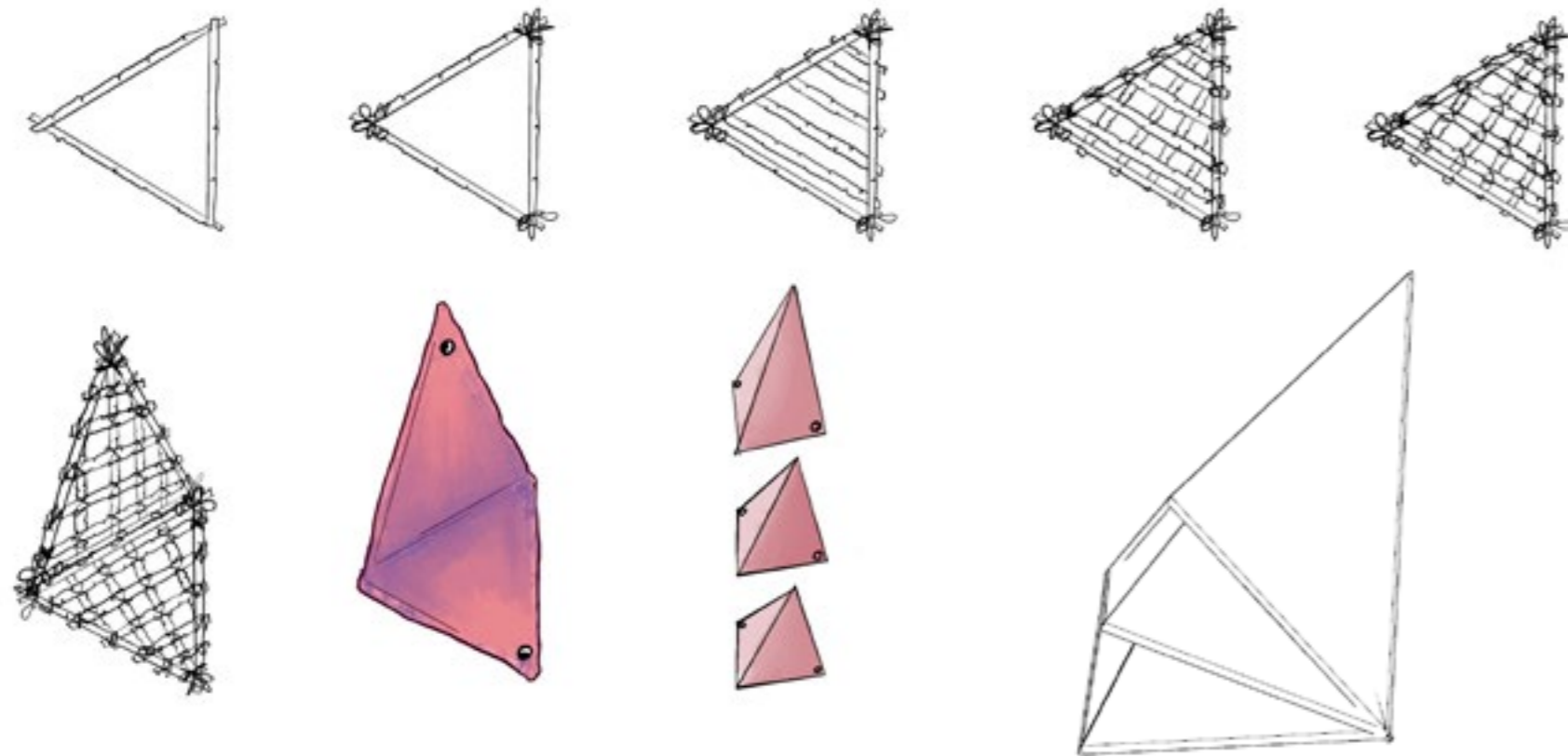

Fig.05 - Sketch



Fig.06 - Axonometric Exploded Drawing

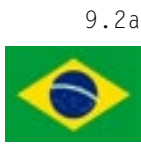

Fig.07 - Wattle & Daub Sketch

Initial Idea: A minimal but effective shading unit that can be built in-site or even pre-fabricated. Rather than separate structures designed for specific needs, a single multi-purpose structure for gathering, resting and shading. The form is rigid and shell-like, while also being functional. The aim was to design an eye-catching structure to remind the Sugar Cane workers that they need to look after themselves.

Materials Used: The three shells that create the main structure would be designed using the Wattle and Daub method, in which either bamboo or sugar-cane poles would be used as the frame and the skeleton, while a bagasse-lime mixture is cast on top of the mesh for structural rigidity to create the shells. For structural integrity, ropes would be used to pull the structure back and pin it to the ground to enhance the stability of the whole. See Fig.06 for the layers and the construction of the structure and Fig.07 for the Wattle & Daub method.

9.2 BRAZIL



9.2a Location:

Brazil is the largest country in both South America and Latin America. It has a total population of more than 210,000,000 people, occupies an area of 8,515,767 km², and borders Argentina, Bolivia, Colombia, Guyana, Paraguay, Peru, Suriname, Uruguay, Venezuela.

Climate & Precipitation:

Brazil has a humid tropical and subtropical climate except for a drier area in the Northeast. Much of the country receives 1,000-1,800 mm precipitation annually, but this often is much heavier in parts of the

Amazon basin and the sea-facing rim of the Serra do Mar.

Temperatures below the equator are high, averaging above 25 °C, with little seasonal variation near the equator. Average temperatures below the Tropic of Capricorn range from 13 °C to 22 °C.

Industry Location & Production:

Brazil supplies 50% of the world's sugar, making it the world's top producer and exporter of sugarcane. Annual Production currently stands at 654.8m tonnes of sugarcane per year.

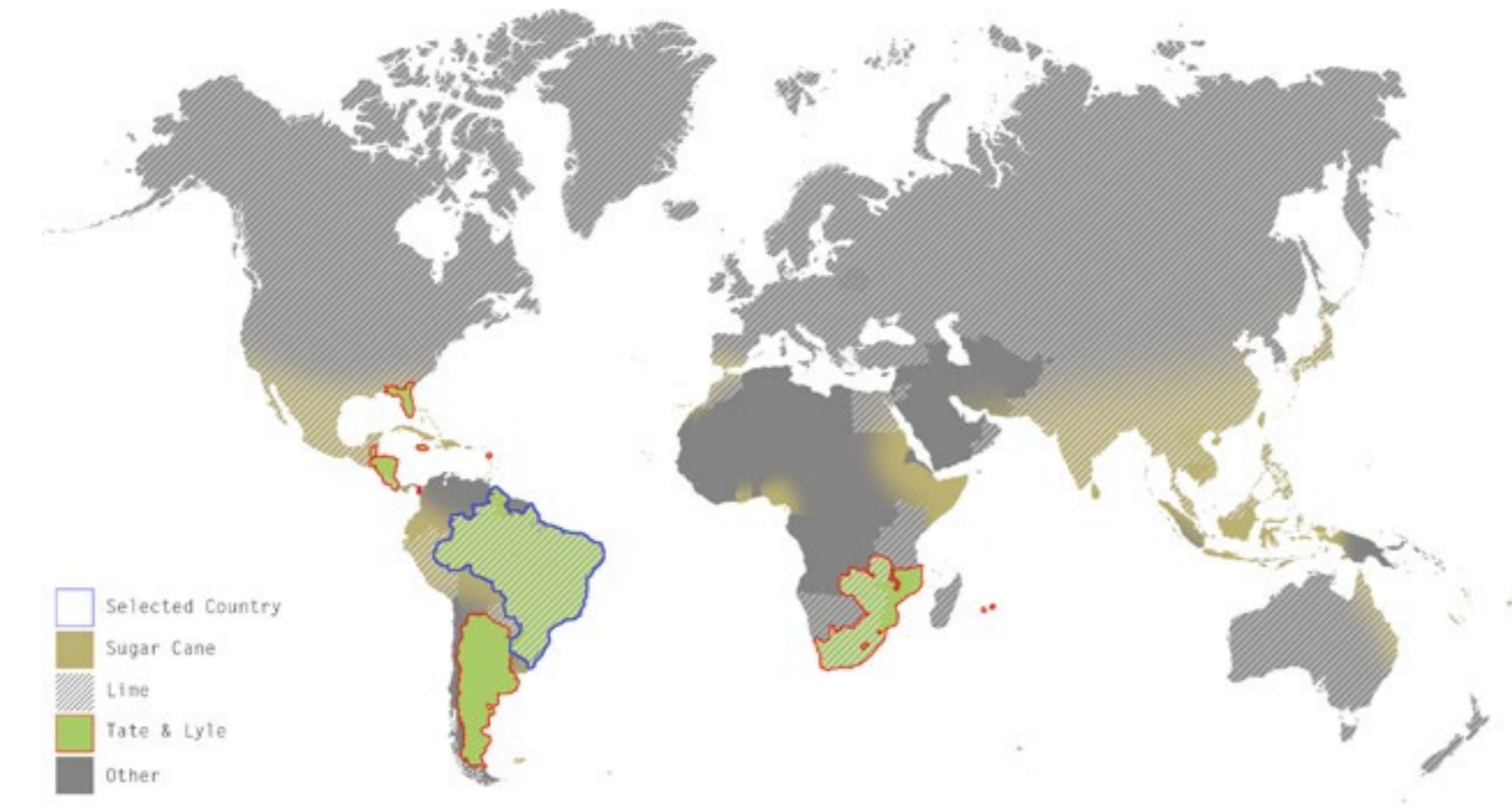

Fig.01 - Brazil in World Map

Belize: Bagasse, production (thousand metric tons)

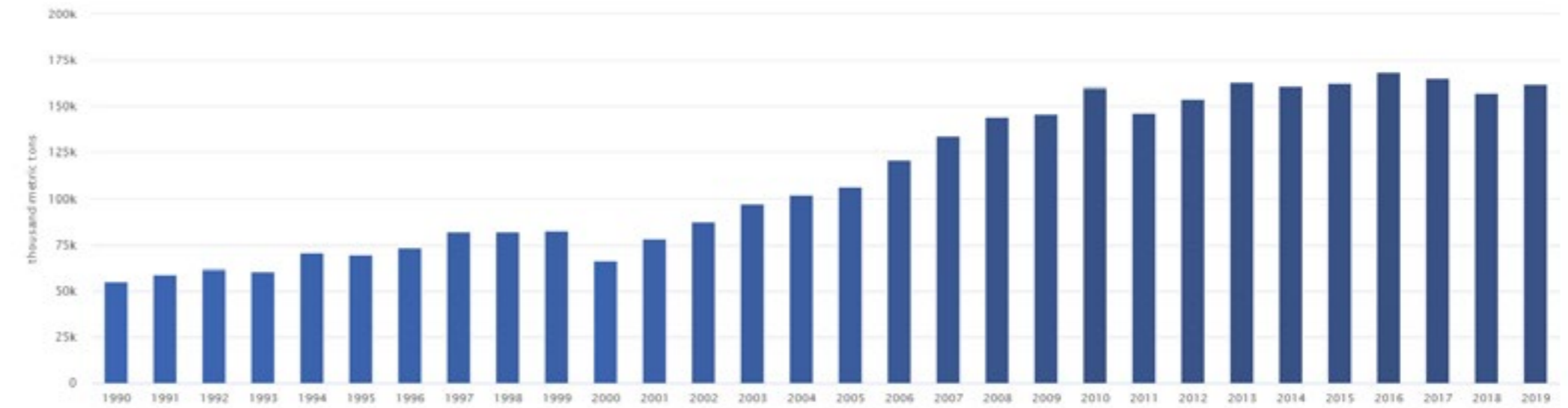

Fig.02 - Bagasse production in Brazil

All countries: 2017 Bagasse, production (thousand metric tons)

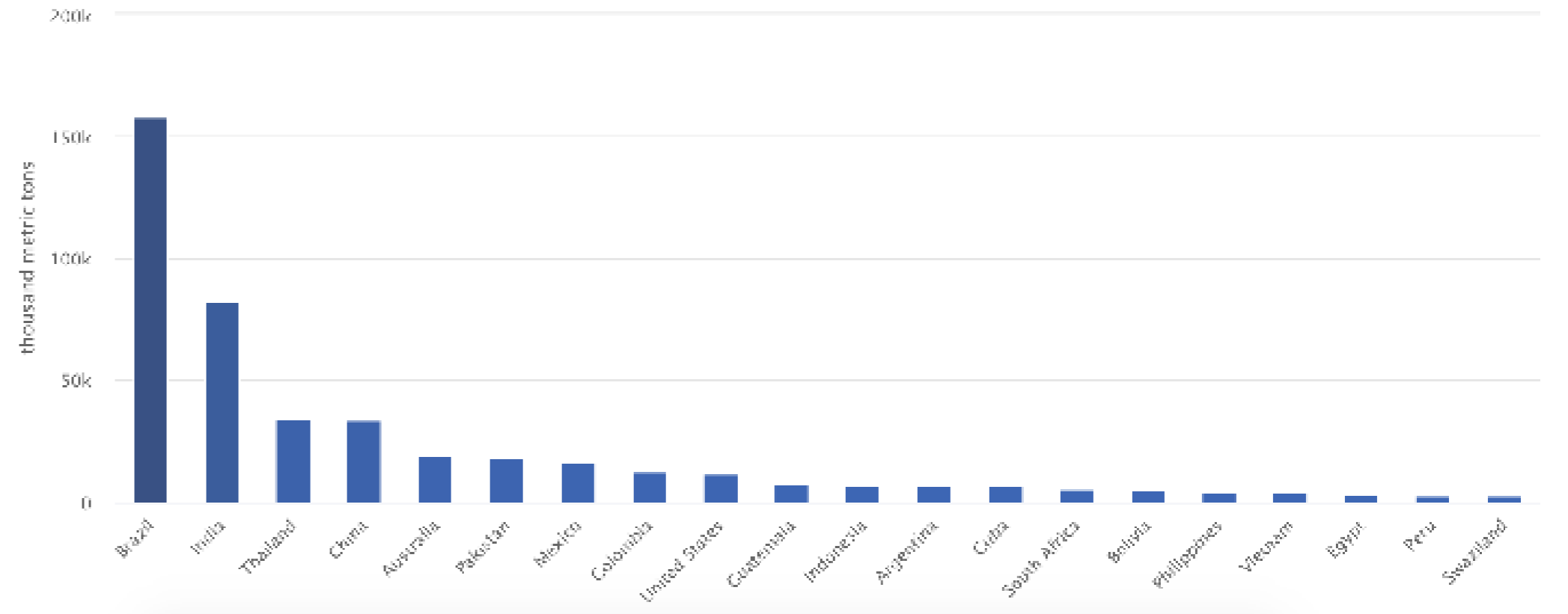

Fig.03 - Bagasse production in the world



Working and Living Conditions of Manual Cutters:

Sugarcane plantation work in Brazil has its roots in the colonial period and is historically associated with poor living and working conditions. While industrialisation might have brought a promise of improving the work process, until recently, little has changed for the considerable portion of workers who still cut sugarcane manually. The current trends of corporate and government responsibility towards workers' rights appear to be relatively successful in enforcing minimum working and living standards, however, there is still much room for improvement.

In Brazil, similarly to other countries and across the entire agricultural sector, workers involved in the manual cutting of sugarcane are exposed to risks to their health, such as solar radiation, rains, winds, dust from soil, extreme temperatures, pesticide residue, soot from burned sugar cane, and venomous animals. In order to protect themselves workers use hats, handkerchiefs protecting their faces and necks, long-sleeve shirts and pants, and it is also common to use Personal Protective Equipment (PPE), such as safety glasses, leather gloves, leather gaiters along the legs and leather boots with iron tips.

The workers typically live in small towns surrounding the plantations and are transported to the fields in buses. The houses in those towns typically quite crowded, often hosting eight to ten workers. Single men and women live separately and families also live in separate houses. The poverty and substandard living conditions reflect the workers vulnerable position, with lack of security, health services, education, income, decent work, rights, social participation and status.



Fig.04 - Brazil Sugarcane Production Map

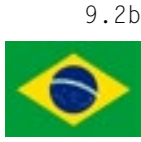

Fig.05 - Sugarcane Cutters in the Field



Fig.06 - Workers Houses

9.2 BRAZIL// the proposal



9.2b **Potential Problems:** While there is much room for improvement to the working conditions for sugarcane workers, there should be equal focus on improving their living conditions and economic circumstances. This way, the cycle of poverty leading to problems with health, education, social inclusion etc., leading to further poverty, often transferred through generations, can be disrupted.

Potential Resources: Bagasse as a waste product of the sugar cane mills. Abundance of earth and kaolin clay.

Potential Answers: Reducing the cost of accommodation while at the same time improving its quality can have a positive effect on workers' finances and general quality of life, reducing the strain of poverty, resulting in better physical and mental health, and social status. This can be achieved by introducing inexpensive alternatives to typical construction materials.

The following proposal is a conceptual standardised construction block that can replace traditional clay masonry in the construction of worker houses. Depending on the materials available in the area, it can either consist of mixed kaolin clay with bagasse, which is then baked in a kiln, or mixed earth with bagasse, which is left to dry naturally. Due to the bagasse content in the block, walls constructed that way would have higher thermal and acoustic performance, leading to improved living conditions. The size and relatively low weight of each block makes it easy to work with, bringing down labour cost and construction times. Blocks that do not form structural walls can be laid upright, improving material economy.

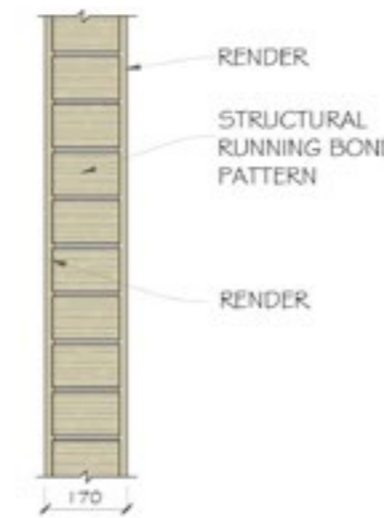
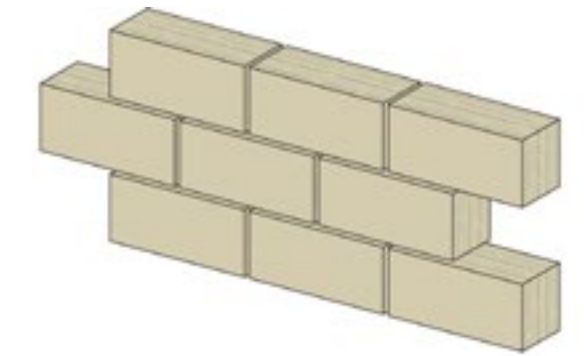
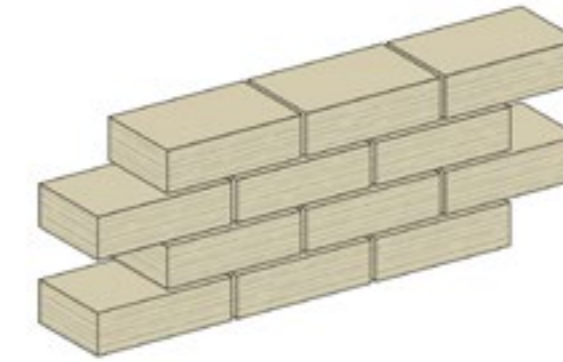
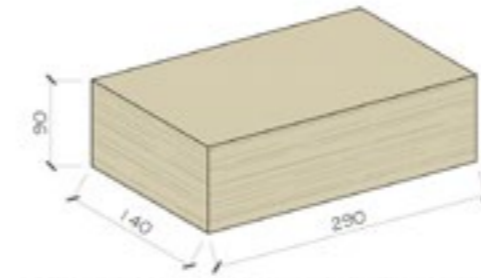
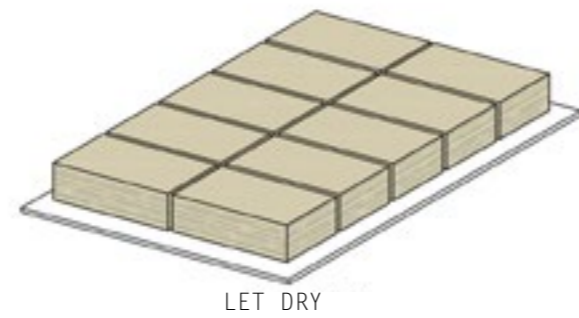
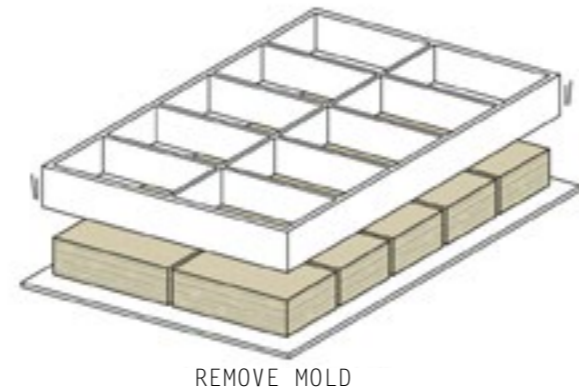
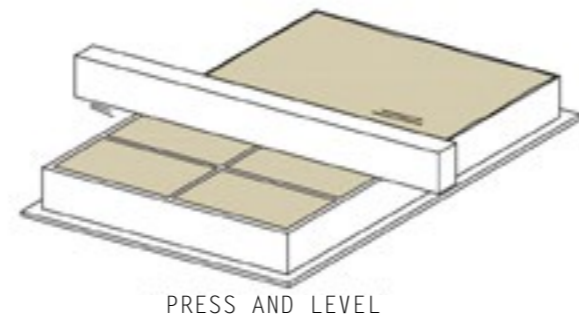

SINGLE BLOCK WALL PROTOTYPE

- Inherent Fire Separation Qualities
- Inherent Thermal Insulation Qualities
- Inherent Acoustic Insulation Qualities
- Suitable for Internal Load-bearing walls

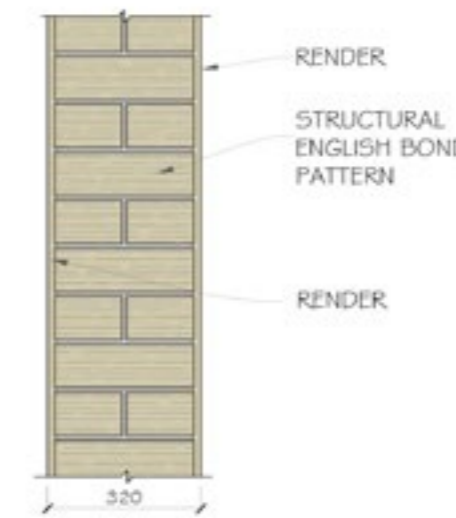

DOUBLE BLOCK WALL PROTOTYPE

- Increased Structural Capacity
- Improved Fire, Thermal and Acoustic Performance
- Suitable for Internal and External Load-bearing walls

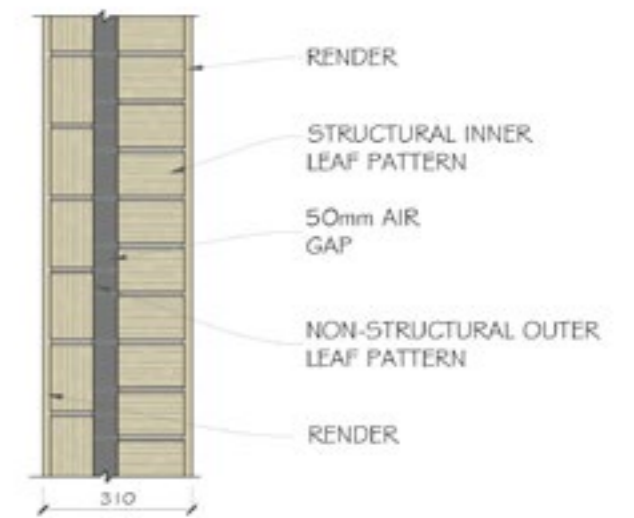

CAVITY WALL PROTOTYPE

- Better Utilisation of Materials
- Improved Thermal Performance
- Air Gap stops damp from penetrating the inner structural leaf, resulting in lower maintenance requirements
- Suitable for External Load-bearing walls

9.3 MALAYSIA



9.3a Location: The Malaysian capital is Kuala Lumpur. The country consists of two noncontiguous regions, which are Peninsular Malaysia (Semenanjung Malaysia) and East Malaysia (Malaysia Timur). The coordinates of the Malaysian capital are 2°30'N 112°30'E.

Climate & Precipitation: Located near the equator, Malaysia's climate is categorized as equatorial. The average rainfall is 250 centimeters (98 in) a year. The average temperature is 27 °C (80.6 °F). The climates of the Peninsula and the East differ. As the climate on the peninsula is directly affected by wind from the mainland.

Industry Location & Production: Malaysia Holdings Berhad (MSM) is a Malaysian sugar manufacturing company engaged in the business of sugar refining in Malaysia. They operate

two sugar refineries through subsidiaries; Malayan Sugar Manufacturing Company Bhd (MSM) in Prai, Penang, and Kilang Gula Perlis Sdn Bhd (KGFP), in Chuping, Perlis. KGFP grows sugar cane on the Chuping Plantation. The sugar mill has a sugar cane crushing capacity of 5,500 mt per day. They have an annual production capacity of over 1.1 million tonnes of refined sugar. KGFP operates an integrated sugar mill and refinery located in Chuping, Perlis. MSM market and sell their products primarily in Malaysia. They also export their products typically when there is an excess in supply after domestic demand has been met.

Conditions of Workers: Unfortunately, MSM is not open with the process of sugarcane harvesting from their plantation. Locally, the size of Sugarcane field is a small land and managed by individuals. Depending on the

size of the field, it usually takes under 2 to 4 workers in a field to maintain and harvest. The workers manually cultivate the sugarcane field from seed until the preparation to export outside the country. The sugarcane field would be on the owner's land which in most cases be in the same village or beside their home.

Time to Harvest: Sugarcane seeds are stem cuttings from yellow sugarcane trees that have reached the age of 7-9 months and are cut along 18-22 cm. Sugarcane seed cuttings are treated with fungicides such as Benomyl or Dieldrin by dipping them into a solution of pesticide. 2,800 - 3,000 yellow sugarcane stalks can produce 2,800 - 3,000 flat sugarcane seeds. They should be planted immediately and delays exceeding 3 days will affect growth.

Common problem in Cane Filed: The main problems faced by farmers are disease and insect attacks pests. There are many types of pests and diseases of rice crops to cause great losses. Pests such as brown beetles, white beetles, green beetles, bear fleas, rice stem caterpillars attack the leaves, stems, and fruits of rice until yield production becomes less and the cost of using pesticides increases.



Fig.02 - Worker in the sugarcane filed



Fig.03 - Farmhut

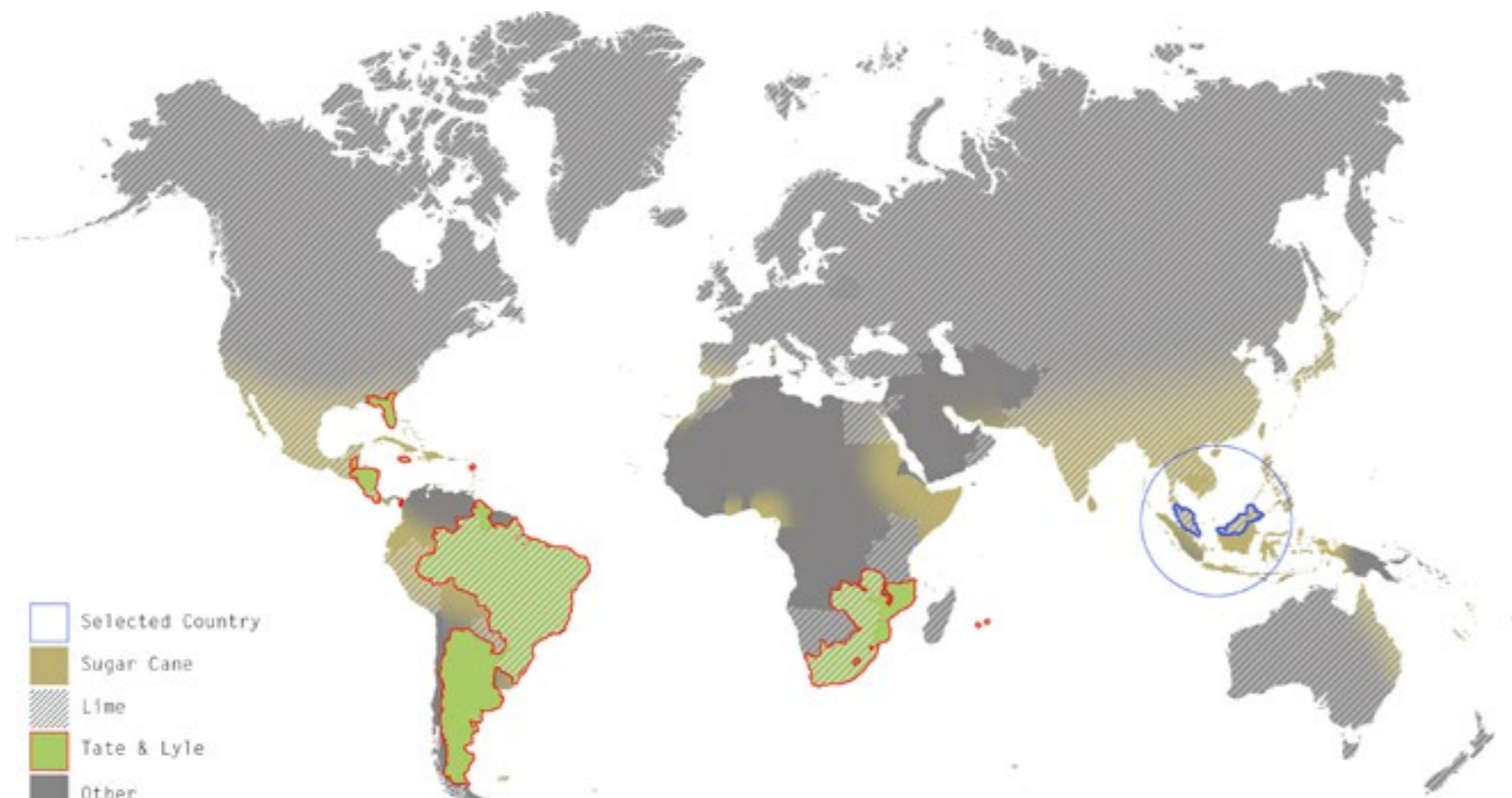

Fig.01 - Malaysia in world map

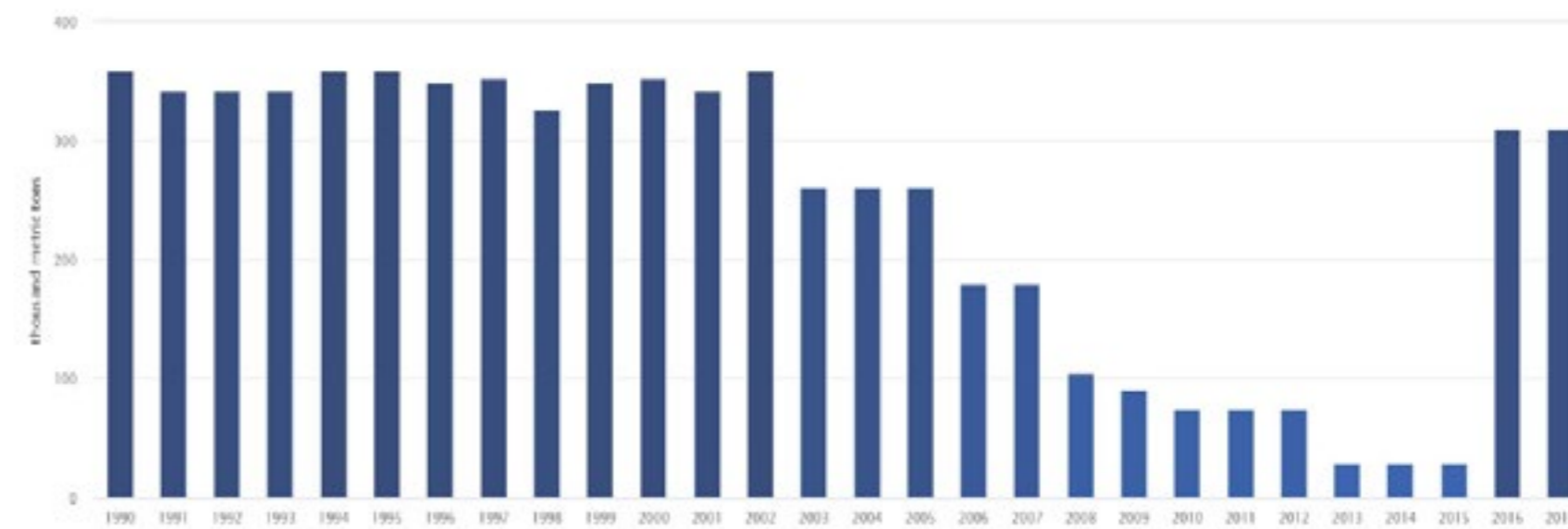

Fig.04 - Bagasse production



9.3 MALAYSIA// the proposal



9.3b Vent Block : A component allowing air ventilated naturally. Wind will naturally ventilate home by entering and leaving through openings. Cooling breezes carry heat out of a building, replacing warmed internal air with cooler external air to effectively lower the temperature of interior spaces. A vent block can be made in many shapes and size. It can be arrange in various manner.

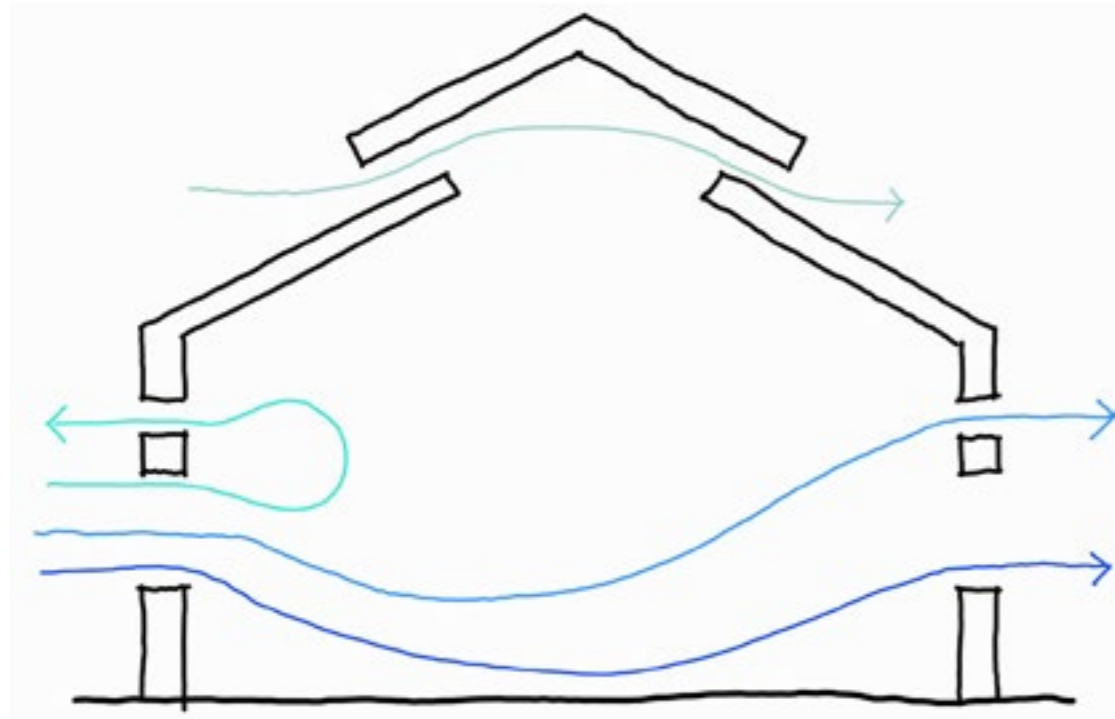

Fig.05 - Natural Ventilation

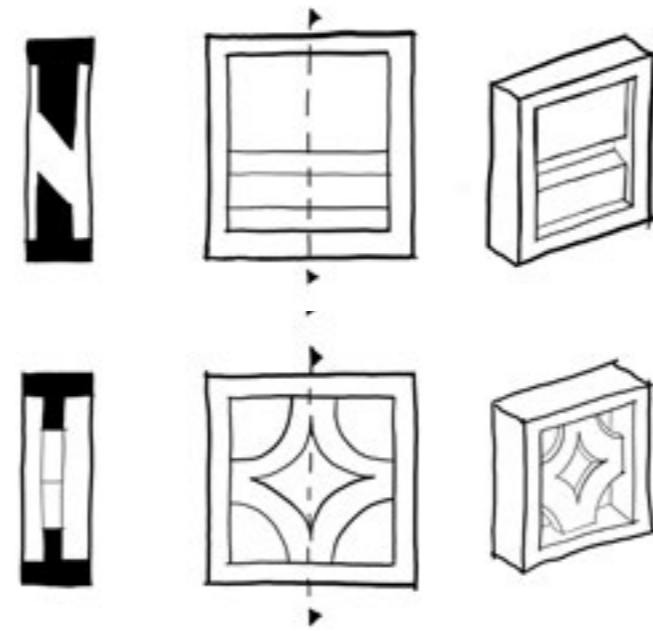

Fig.06 - Variation shapes of mold



Fig.09 - Variation shapes of mold



Fig.10 - Variation shapes of mold

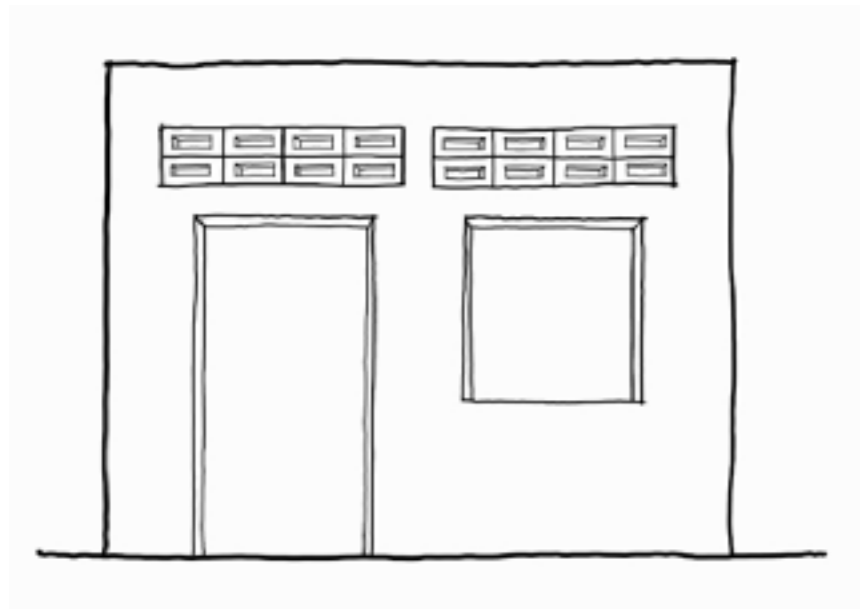

Fig.07 - Placement of ventblock above door and window

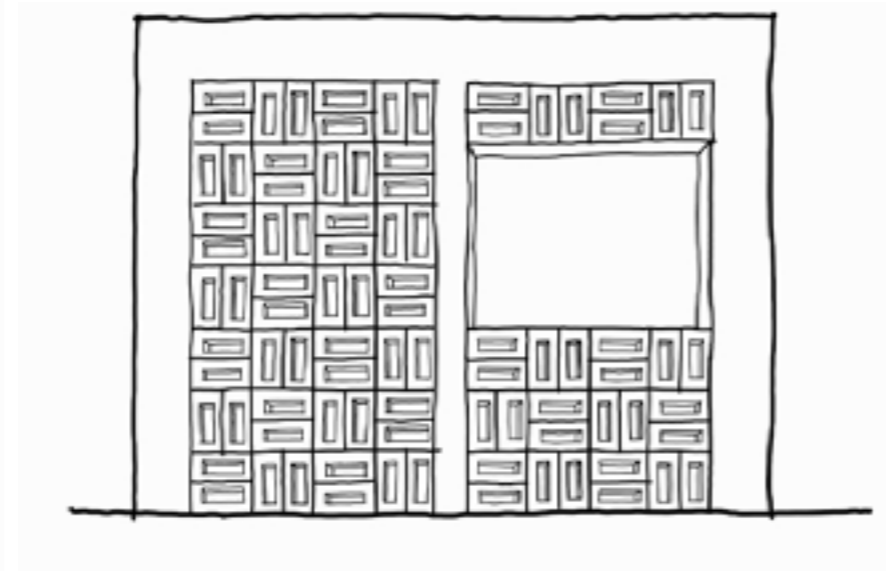

Fig.08 - Placement of ventblock aestheticy



Fig.11 - Variation shapes of mold

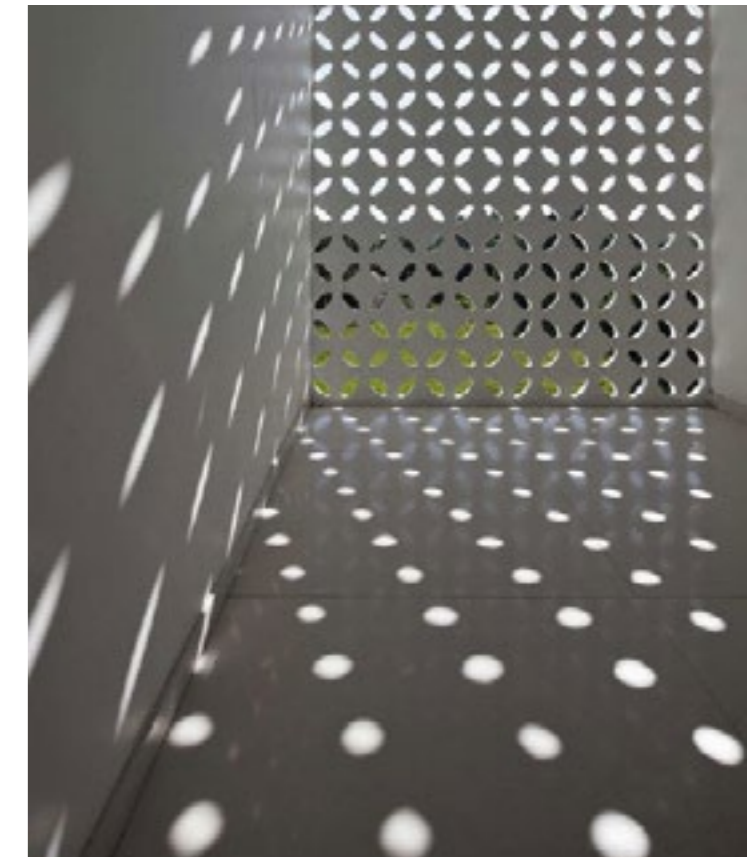

Fig.12 - Variation shapes of mold

9.4 NIGERIA

9.4a **Location:** Nigeria is located on the western coast of Africa. It has a diverse geography, with climates ranging from arid to humid equatorial. Soils in Nigeria, and in Africa generally, are usually of a poorer quality than those in other regions of the world. However, over the centuries Nigerians have utilized agricultural techniques such as slash and burn, intercropping, and the use of shallow planting implements to cope with the shortcomings of the soil.

na climate, with marked wet and dry seasons, prevails in the north and west, while a steppe climate with little precipitation is found in the far north.

Industry Location & Production: Sugarcane production in Nigeria has reduced drastically since the 90s reaching a zero production rate between 2003 and 2005. In 2006 production restarted, but the sugarcane industry has not been getting the attention it deserves from the government or investors, and for these reasons Nigeria production of sugarcane is projected to drop. Many more factors are in the way of the development of this sector: from agricultural challenges to the increasing price of water and fuel.

Climate & Precipitation: Nigeria has a tropical climate with variable rainy and dry seasons, depending on location. It is hot and wet most of the year in the southeast but dry in the southwest and farther inland. A savan-

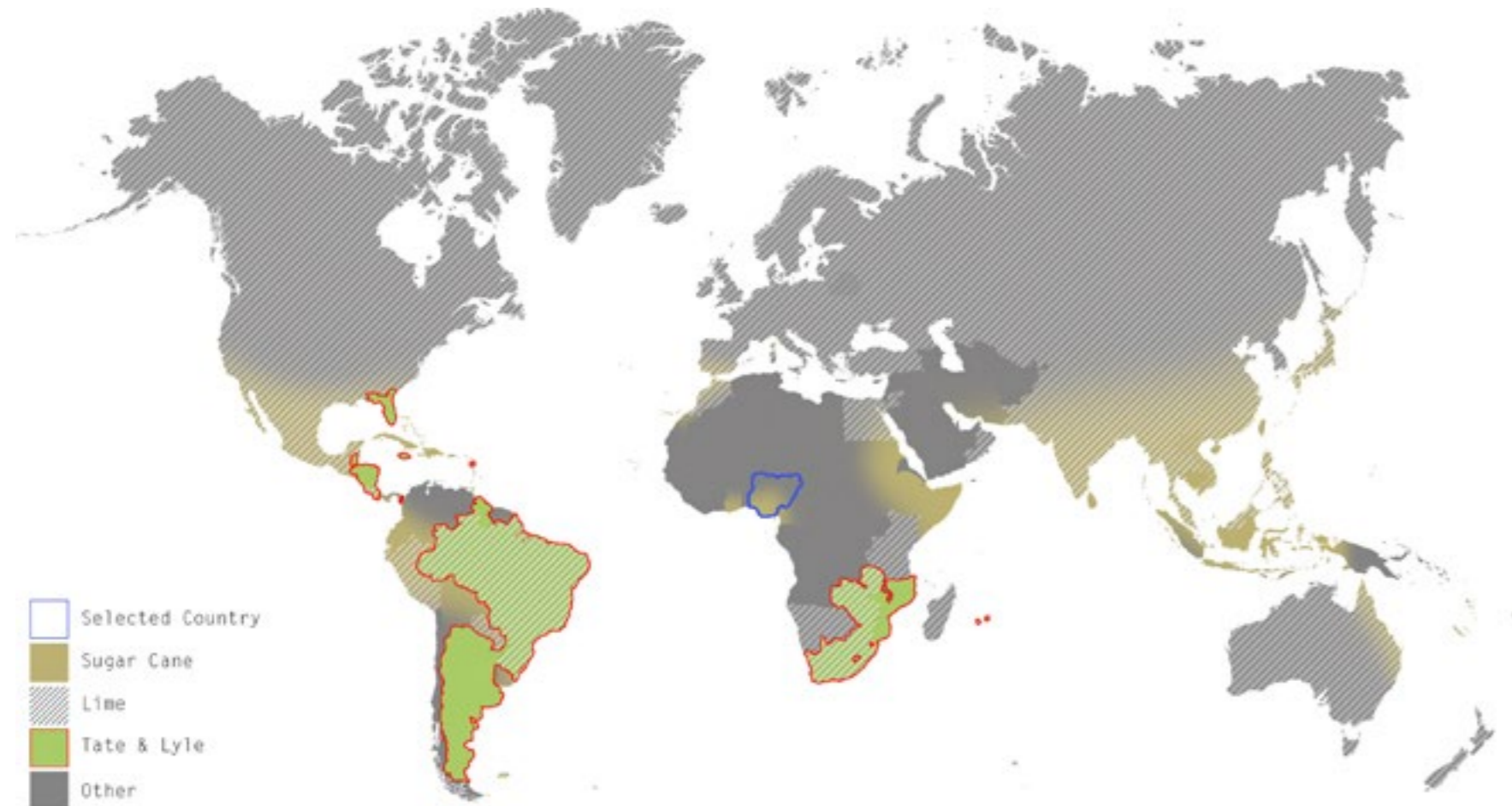

Fig.01 - Nigeria in world map

Nigeria: Bagasse, production (thousand metric tons)

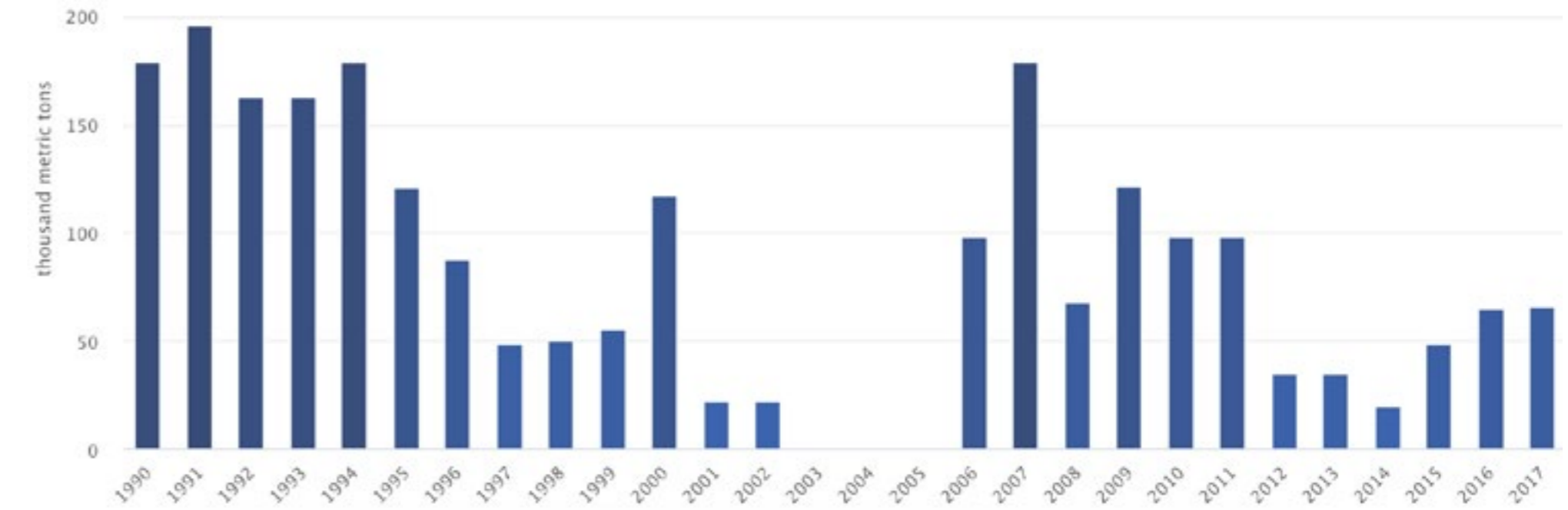

Fig.02 - Bagasse production in Nigeria

All countries: 2017 Bagasse, production (thousand metric tons)

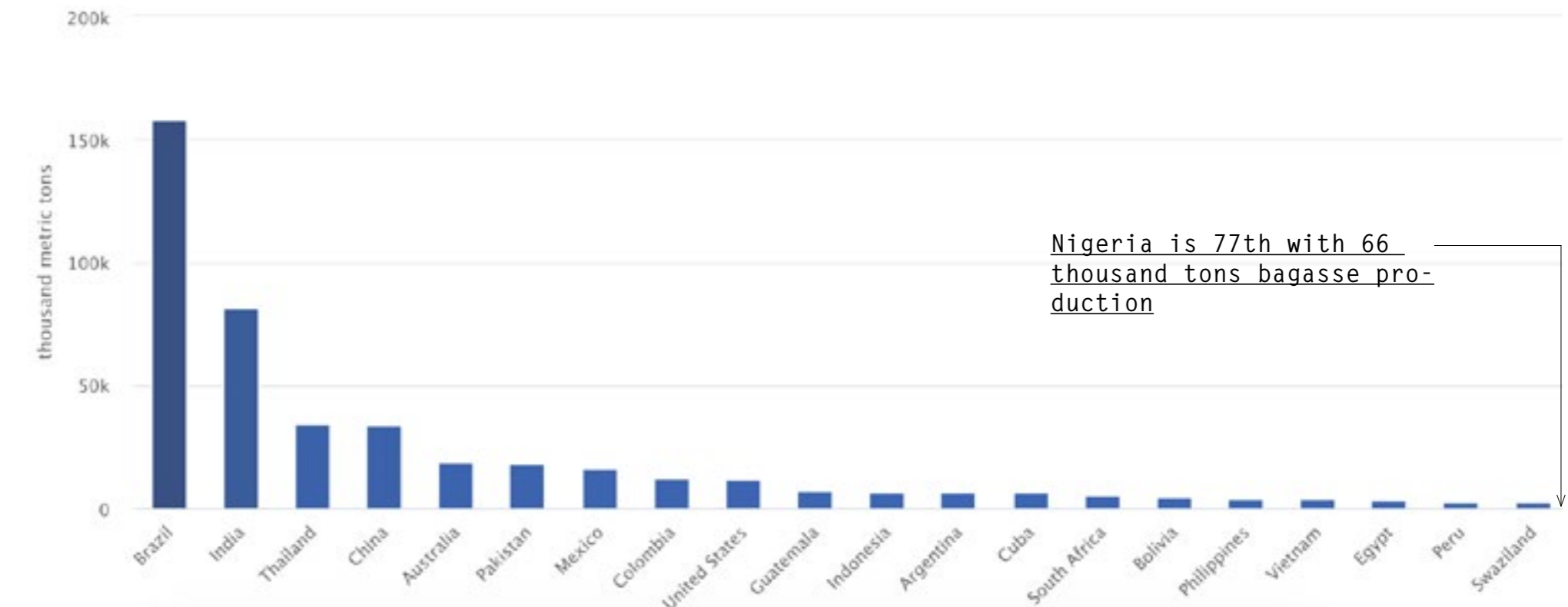

Fig.03 - Bagasse production in the worlds



Working Conditions of Manual Cutters:

Sugarcane production in Nigeria has reduced drastically since the 90s reaching a zero production rate between 2003 and 2005. In 2006 production restarted, but the sugarcane industry has not been getting the attention it deserves from the government or investors, and for these reasons Nigeria production of sugarcane is projected to drop.

Many more factors are in the way of the development of this sector: from agricultural challenges to the increasing price of water and fuel.

Labour cost doesn't seem to be an issue, in fact, from my research and conversation with local people, there are no dedicated farm-houses in the plantations for laborers. The latter are local people, mainly young men (fig.5), who come to the plantation as often as needed from their homes.

Because sugarcane business is not considered to be as lucrative as other businesses in the country, very little concern is given to the working condition in the plantations, hence the lack of data on this very topic.

Laborers therefore have to suffer as a result of their employer's and country government neglect.

Most of the times these plantations can be quite far away from the nearest town, and, just like in the farms in villages, one has to come well equipped to the farm: laborers need to arrange their food, drinking water and personal hygiene/toileting.

Water is extremely scarce and there are no proper water systems in place for irriga-

tion or hygiene, the little water available is used for irrigate the plantation (fig.6). This water non-potable, it could be used for hygiene purposes by the laborers, but the way the water system has been designed makes this difficult.



Fig.05 - Young Sugarcane Cutters in the Field



Fig.06 - Water Scarcity in the Field

9.4 POTENTIAL USE OF BAGASSE \ \ the proposal

9.4b **Proposal:**
 An ecological toiletry system for cane manual cutters.

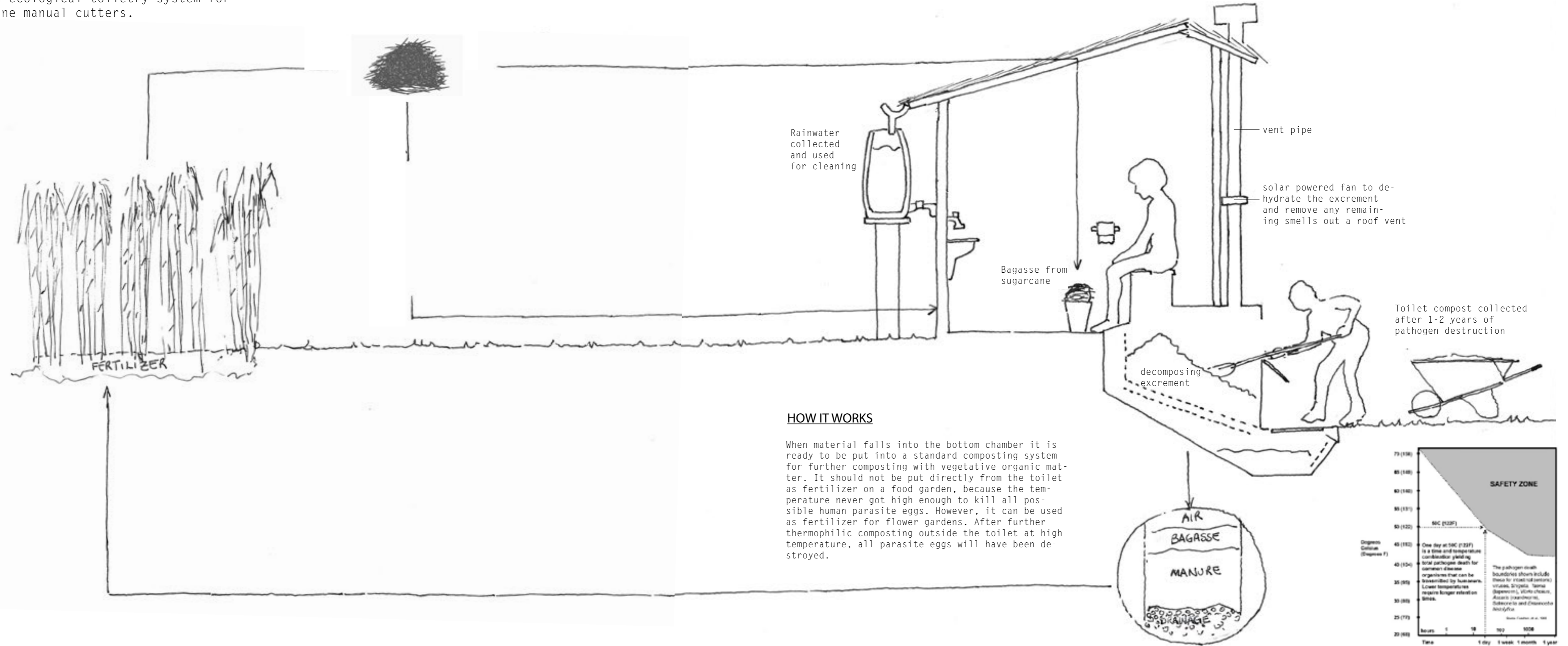

HOW IT WORKS

When material falls into the bottom chamber it is ready to be put into a standard composting system for further composting with vegetative organic matter. It should not be put directly from the toilet as fertilizer on a food garden, because the temperature never got high enough to kill all possible human parasite eggs. However, it can be used as fertilizer for flower gardens. After further thermophilic composting outside the toilet at high temperature, all parasite eggs will have been destroyed.

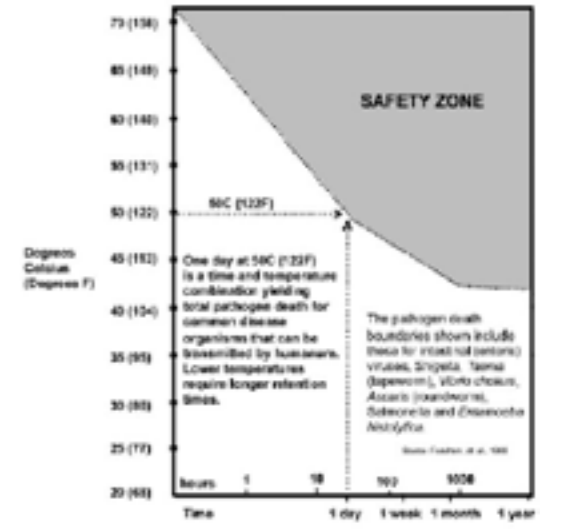

9.5 SOUTH AFRICA



9.5a

Location: South Africa is a country on the southernmost tip of the African continent, marked by several distinct ecosystems. Inland safari destination Kruger National Park is populated by big game. The Western Cape offers beaches, lush winelands around Stellenbosch and Paarl, craggy cliffs at the Cape of Good Hope, forest and lagoons along the Garden Route, and the city of Cape Town, beneath flat-topped Table Mountain. The sugarcane growing areas of South Africa are KwaZulu-Natal, Mpumalanga and the Eastern Cape (fig 1, 2, 3).

Climate & Precipitation: South Africa is a relatively dry country, with an average annual rainfall of about 464 mm. While the Western

Cape gets most of its rainfall in winter, the rest of the country is generally a summer-rainfall region. South Africa's coastal regions are therefore relatively warm in winter.

Conditions of Workers: In South Africa Sugar Cane harvesting is predominantly a manual exercise, although mechanical harvesting is conducted in parts of Mpumalanga and also the Midlands. At harvest, cane stalks are cut at the base and the tops of the cane stalk are cut off to remain behind in the field.

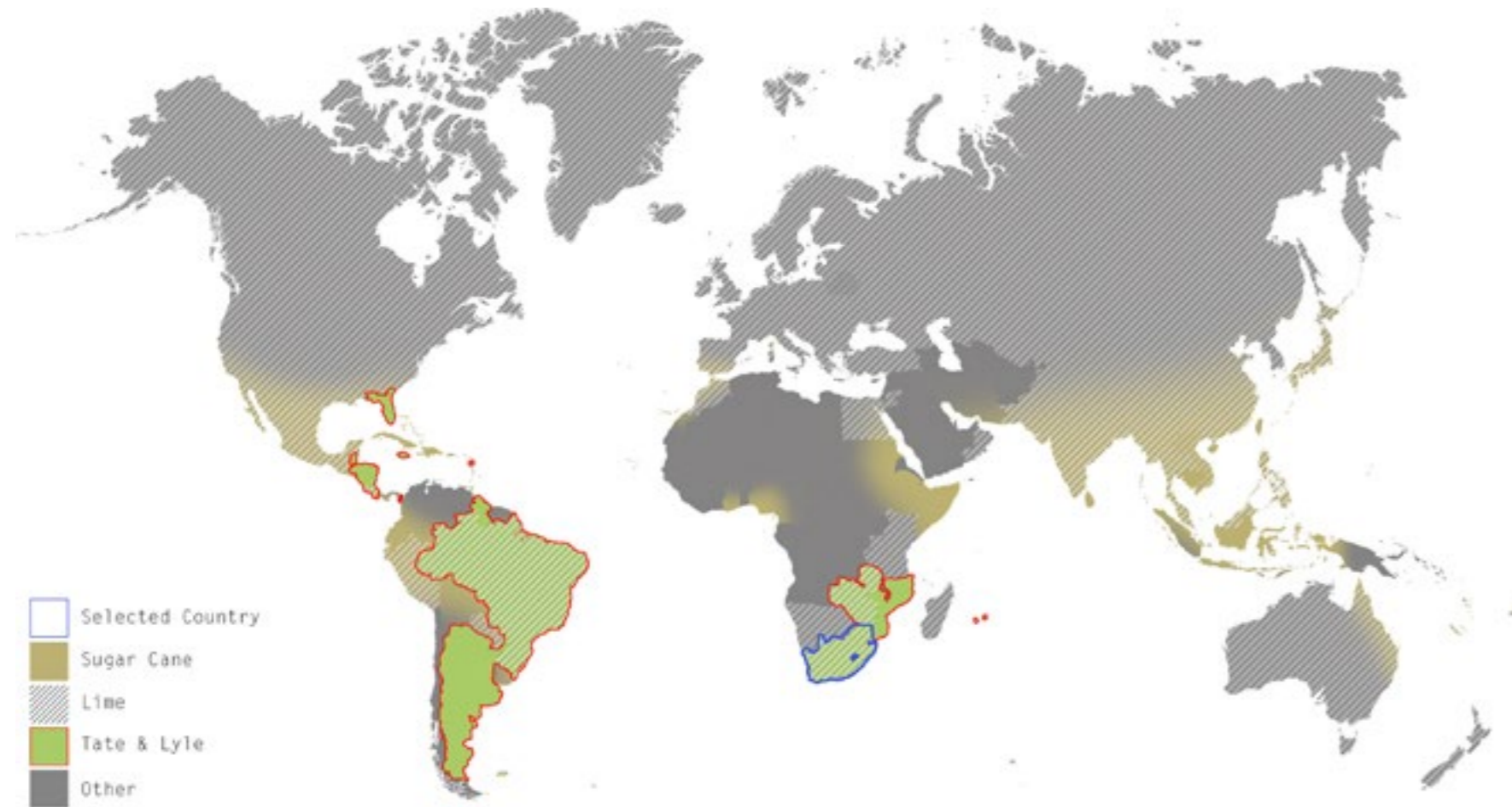
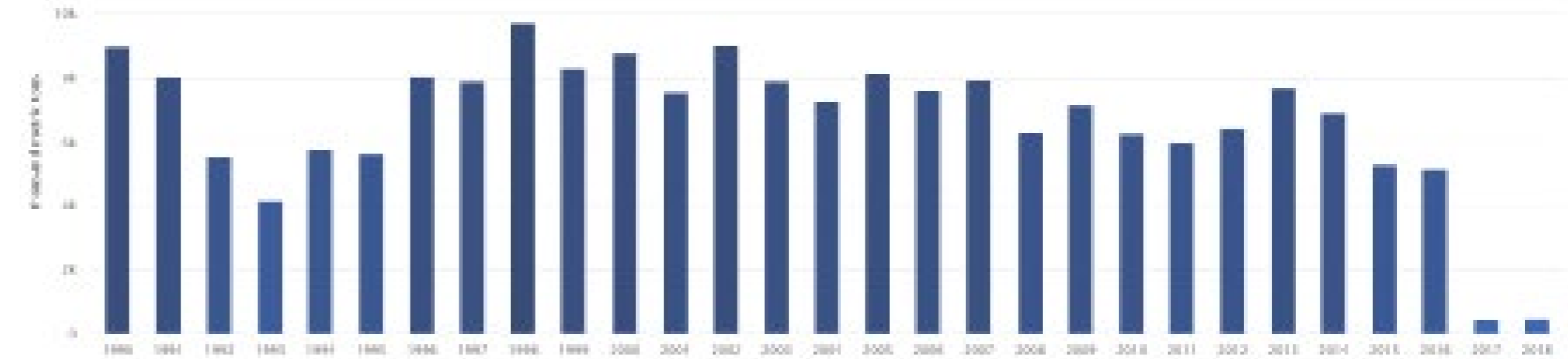

Fig.01 - Nigeria in world map

South Africa: Bagasse, production (thousand metric tons)



All countries: 2017 Bagasse, production (thousand metric tons)

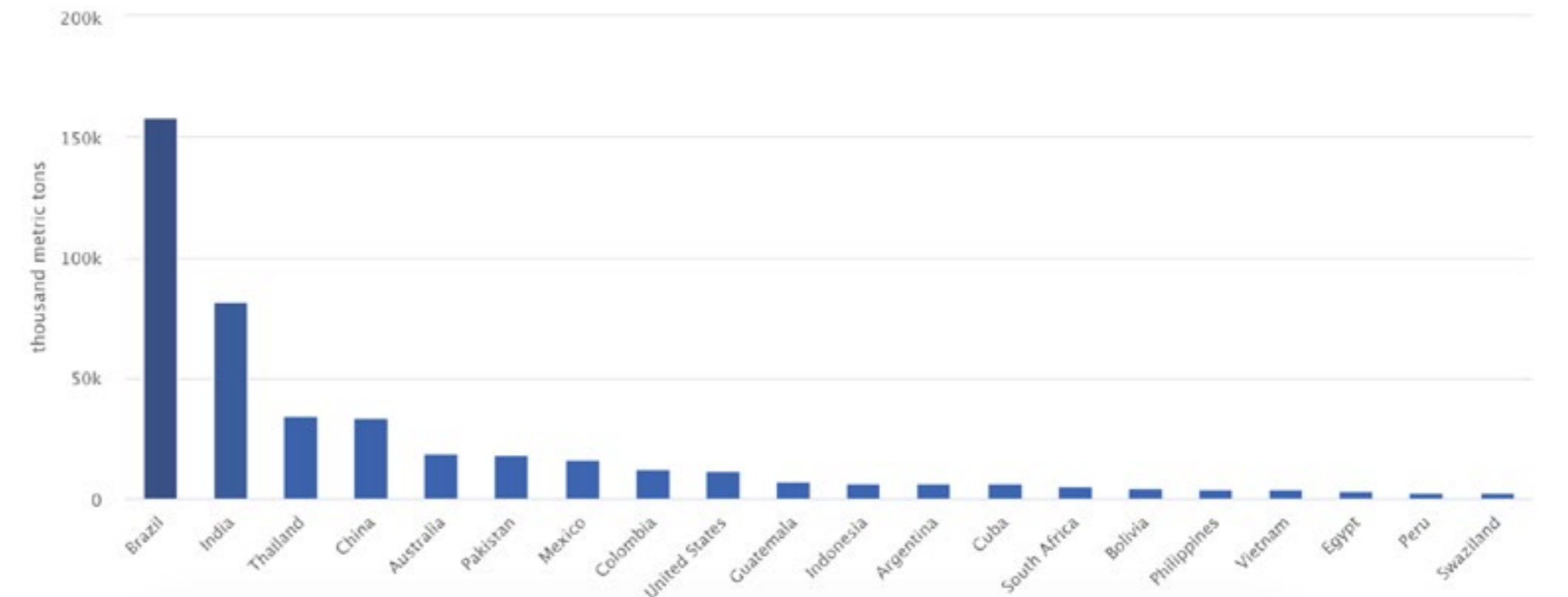



Fig.04- Women manually harvesting sugarcane, covered to protect themselves from the heat



Fig.05- Male harvesting sugarcane.

Sugar Cane Harvesting in South Africa: Following planting, the crop can be cut back (ratooned) up to seven times depending on the management practices. It is expected that a grower replants 10% of the farm annually. Sugar Cane harvesting in South Africa is predominantly a manual exercise, although mechanical harvesting is conducted in parts of Mpumalanga and also the Midlands. At harvest, cane stalks are cut at the base and the tops of the cane stalk are cut off to remain behind in the field.

Time to Harvest: Sugarcane is grown all year round, with the length of the growth (ratoon) cycle varying depending on geographic location and climate. In South Africa, sugarcane in irrigated areas is a 12-month crop, which reaches maturity for harvesting anytime between late February/early March until December. In the rain-fed areas, the crop cycle is ideally around 15 months, also being harvested between March and December each year. In the higher altitude areas of the Midlands, the crop cycle extends from eighteen months to two years.

Common Problems in Cane Fields: Problems that are faced in the sugar cane fields are, heat, dehydration, diseases, pests and physical hazards such as Sugar Cane leaves. Workers use mesh gear and shading in the form of canopies or tents.



9.5 POTENTIAL USE OF BAGASSE \ \ the proposal



9.5b Potential Problems: The need is to rest away from the heat under a shelter working during the warmest times of the year.

Potential Resources: Bagasse as a side/waste product of the Sugar Cane mills. Bamboo is found on the east side of South Africa. Lime could be transported at low costs.

Potential Answers: Due to the harsh heat of South Africa sunshading elements and structures are a necessity for the Sugar Cane workers. The structure is built to keep heat away as the workers rest and during their lunch hours.

Design Purpose: The design is to protect the field workers from the harsh heat during their lunch/break hours under a shelter designed to prevent sun directly entering the dining area. The Bajareque wall technique is designed with sugarcrete which, is tested to be a successful insulation material preventing heat to pass through to the interior space.

Construction: Using the Bajareque wall technique, this design follows a similar concept replacing mud with sugarcrete. The Bagasse mixture placed into the box frame, compressed whilst wet to create a strong block. (Fig.08). Structure template is placed into the box in order to shape the bagasse according to the structure and around it, once compressed and dried the bagasse mixture is then ready to be placed in the pre built bamboo structure. (Fig.09).

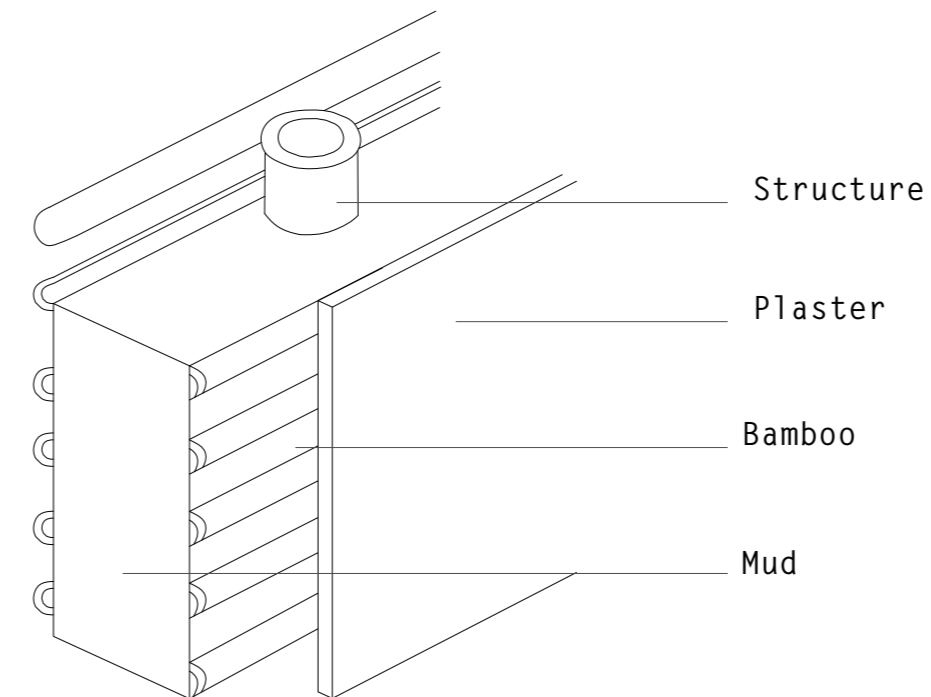
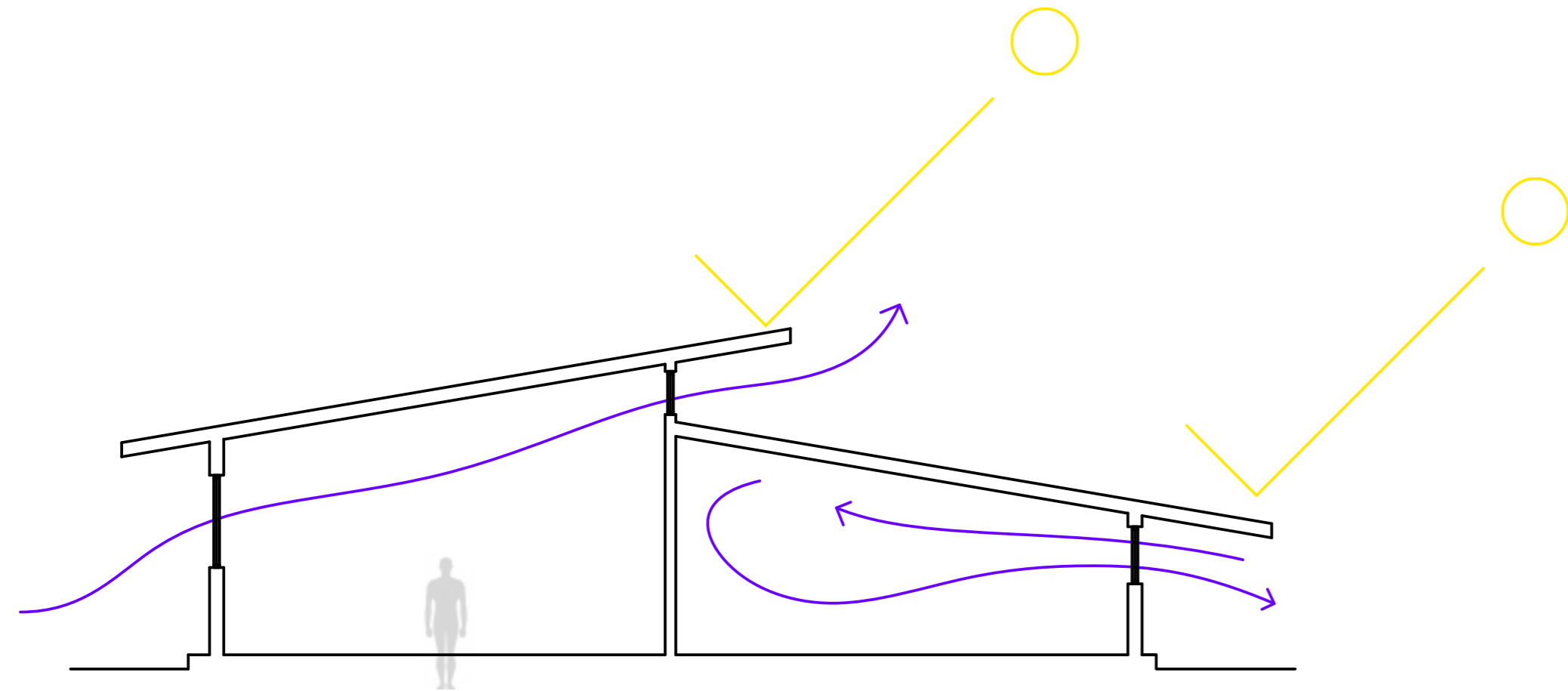

Fig.07- Original Bajareque Wall

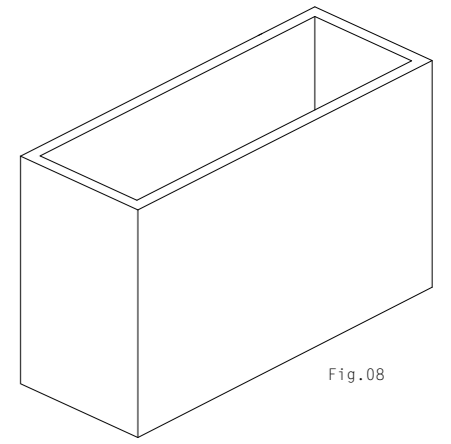

Fig.08

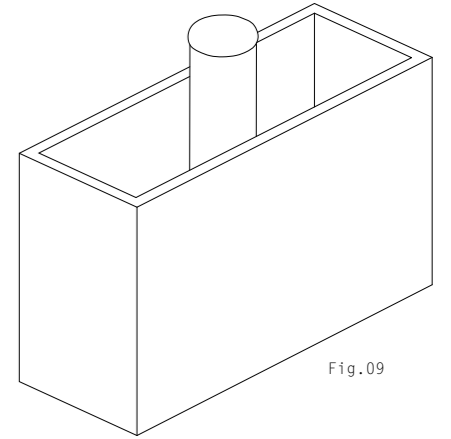

Fig.09

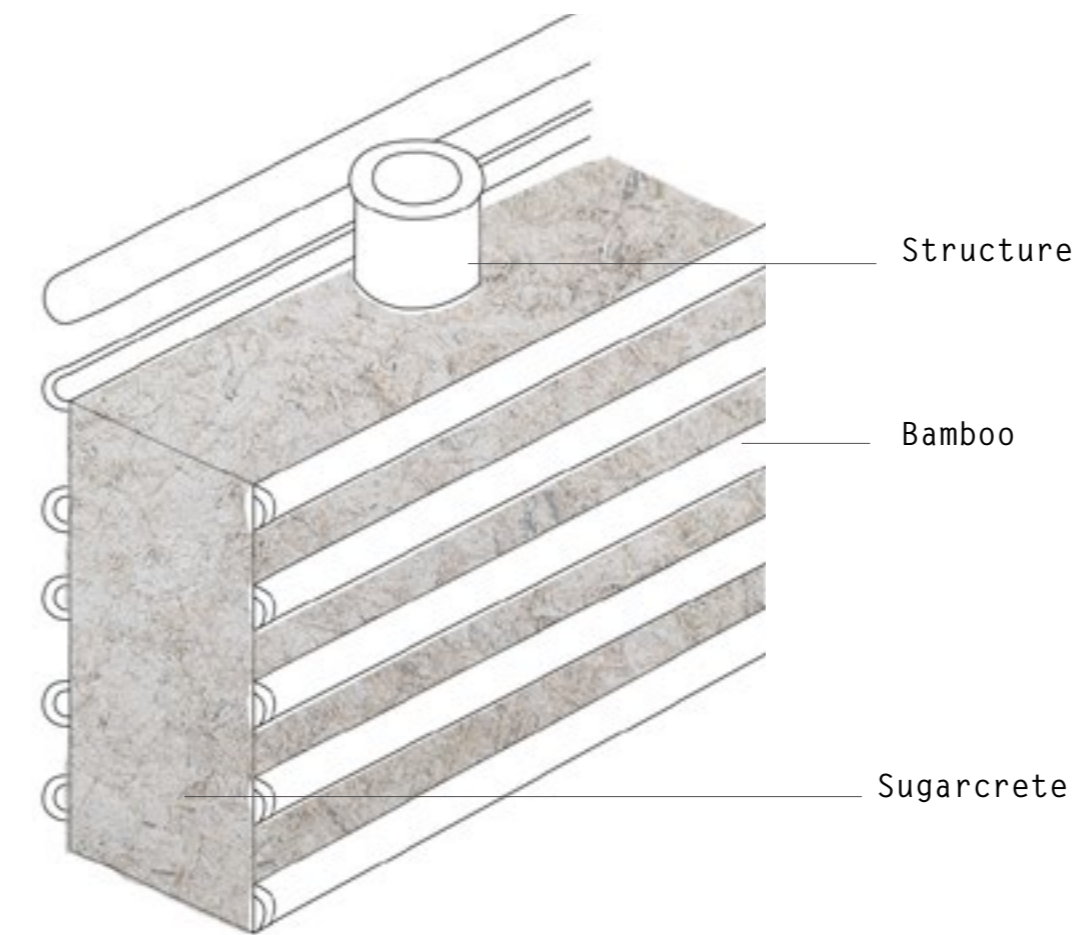

Fig.12- South Africa Design Technique using sugarcrete

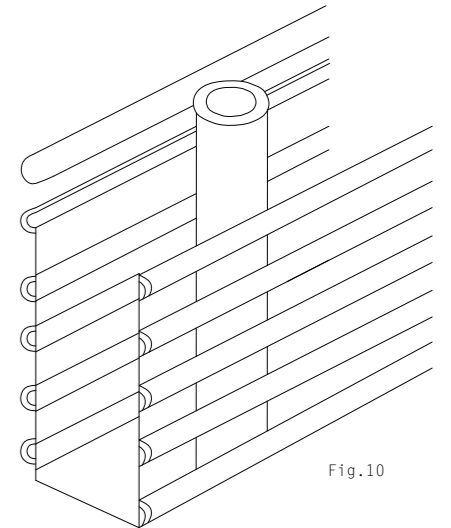

Fig.10

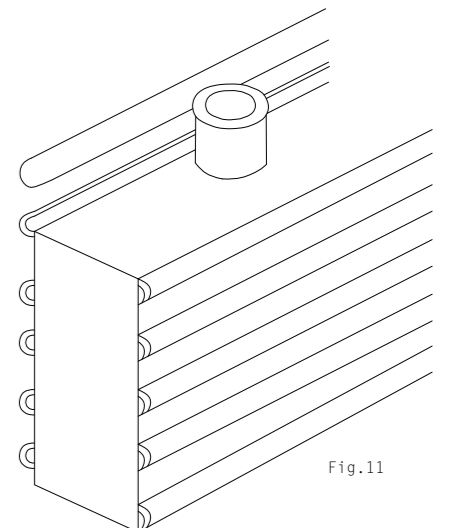

Fig.11

10.0 REFERENCES & NOTES

- https://trphoto.photoshelter.com/image?_bqG=5&_bqH=eJzLjkovy3WKyi_PzT-NIys2yKAsvsjTwcApyLfe0MjQ0tzIOMABhIOk-Z7xLsbFtcmp5Y1JyY16rmGR8a7BoU7.1iGwqS9_PP9M4rMy0ydCpXi3d0DrEtTgUqzAAAwdo-eMw--
- <https://www.hempbuild.ie/shop>
- <https://www.mbhlplc.co.uk/michelmersh>
- <https://www.biopak.com/uk/resources/what-is-bagasse#:~:text=Bagasse%2C%20other-wise%20known%20as%20sugarcane,the%20sugarcane%20plant%20is%20harvested.&text=But%20today%2C%20it%20is%20used,as%20a%20fuel%20for%20factories.>
- <https://en.wikipedia.org/wiki/Sugarcane>
- <https://en.wikipedia.org/wiki/Bagasse>
- https://en.wikipedia.org/wiki/London_oxide
- Brazilian Farmers |. 2021. Sugarcane | Brazilian Farmers. [online] Available at: <<https://brazilianfarmers.com/sugarcane/>> [Accessed 4 October 2021].
- Sugar Cane Production Volume in Brazil 2021 | Statista [online] Available at: <<https://www.statista.com/statistics/742530/sugar-cane-production-volume-brazil/>> [Accessed 4 October 2021].
- <https://www.oxfam.org/en/brazil-extreme-inequality-numbers>
- https://web.archive.org/web/20070902135312/http://odia.terra.com.br/economia/htm/geral_120564.asp
- <https://www.aviculturaindustrial.com.br/imprensa/agronegocio-tem-oito-entre-dez-produtos-1%C3%ADderes-das-exportacoes-brasileiras/20200102-130051-c255>
- https://www.researchgate.net/figure/Map-of-sugarcane-crops-in-Brazil_fig1_5380890
- <http://sugar-asia.com/brazil-sugar-glut-pushes-sugar-mills-into-ethanol-to-sustain-market-price/>
- <https://www.brick.org.uk/admin/resources/brick-sustainability-report-2016-1.pdf>
- <https://www.brick.org.uk/admin/resources/g-the-uk-clay-brickmaking-process.pdf>
- <https://www.hitchcockandking.co.uk/h-k-news/types-of-bricks/>
- <https://smartbrickservices.co.uk/different-types-of-bricks>
- <https://www.homebuilding.co.uk/advice/types-of-brick>
- <https://www.homestratosphere.com/types-of-bricks/>
- https://commons.wikimedia.org/wiki/File:Comparison_house_brick_size.svg
- <https://www.kk-99.top/products.aspx?cname=cavity+insulation&cid=6>
- <https://www.archisoup.com/brick-dimensions>
- <https://www.statista.com/statistics/472894/annual-brick-production-great-britain/>
- <https://www.theconstructionindex.co.uk/news/view/uk-brick-makers-are-failing-to-meet-demand>
- <https://www.modernmasonry.co.uk/Precast/media/BPMediaLibrary/MMA/Publications/MM-Easy-Guide-Bricks.pdf>
- <https://www.brick.org.uk/admin/resources/brick-sustainability-report-2016-1.pdf>
- <https://civilsir.com/weight-of-a-brick/>
- <https://www.gobrick.com/docs/default-source/read-research-documents/technicalnotes/9-manufacturing-of-brick.pdf?sfvrsn=0>
- <https://civilblog.org/2014/02/25/4-primary-steps-involves-in-brick-manufacturing/>
- <https://oec.world/en/profile/bilateral-product/bricks/reporter/gbr?redirect=true>
- <https://touchstoneblog.org.uk/2014/10/bo-riss-brick-made-at-home-but-brick-imports-are-rocketting/>
- <https://www.brick.org.uk/admin/resources/g-the-uk-clay-brickmaking-process.pdf>
- <https://www.brick.org.uk/admin/resources/g-the-uk-clay-brickmaking-process.pdf>